

# POWER WAVE F355i

For use with machines Code 10916, 11251



This manual covers equipment which is no longer in production by The Lincoln Electric Co. Specifications and availability of optional features may have changed.

## Safety Depends on You

Lincoln arc welding and cutting equipment is designed and built with safety in mind. However, your overall safety can be increased by proper installation ... and thoughtful operation on your part. **DO NOT INSTALL, OPERATE OR REPAIR THIS EQUIPMENT WITHOUT READING THIS MANUAL AND THE SAFETY PRECAUTIONS CONTAINED THROUGHOUT.** And, most importantly, think before you act and be careful.

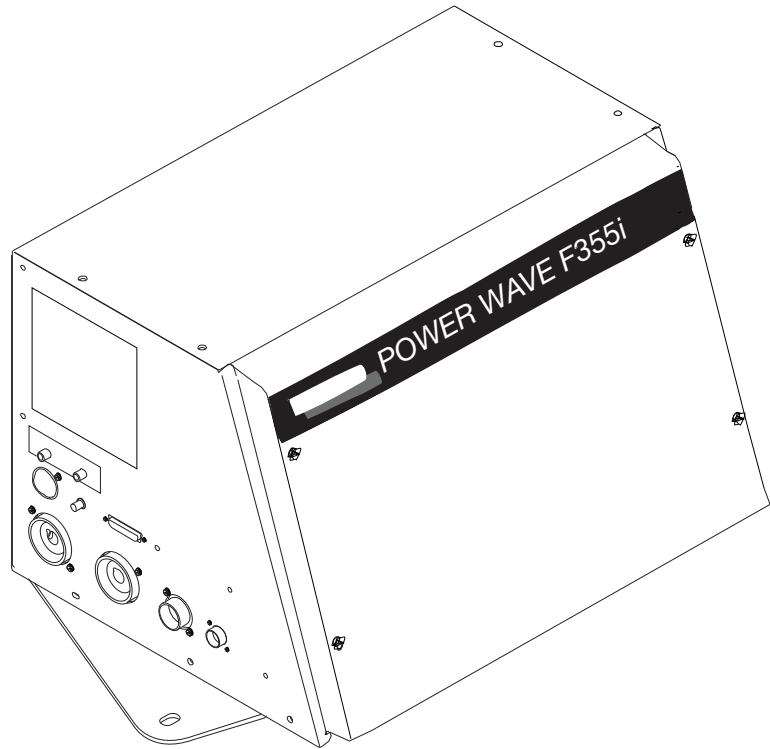

## OPERATOR'S MANUAL



**LINCOLN**<sup>®</sup>  
**ELECTRIC**

Copyright © 2005 Lincoln Global Inc.

- World's Leader in Welding and Cutting Products •
- Sales and Service through Subsidiaries and Distributors Worldwide •

Cleveland, Ohio 44117-1199 U.S.A. TEL: 216.481.8100 FAX: 216.486.1751 WEB SITE: [www.lincolnelectric.com](http://www.lincolnelectric.com)

## ⚠ WARNING

### ⚠ CALIFORNIA PROPOSITION 65 WARNINGS ⚠

Diesel engine exhaust and some of its constituents are known to the State of California to cause cancer, birth defects, and other reproductive harm.

The Above For Diesel Engines

The engine exhaust from this product contains chemicals known to the State of California to cause cancer, birth defects, or other reproductive harm.

The Above For Gasoline Engines

**ARC WELDING CAN BE HAZARDOUS. PROTECT YOURSELF AND OTHERS FROM POSSIBLE SERIOUS INJURY OR DEATH. KEEP CHILDREN AWAY. PACEMAKER WEARERS SHOULD CONSULT WITH THEIR DOCTOR BEFORE OPERATING.**

Read and understand the following safety highlights. For additional safety information, it is strongly recommended that you purchase a copy of "Safety in Welding & Cutting - ANSI Standard Z49.1" from the American Welding Society, P.O. Box 351040, Miami, Florida 33135 or CSA Standard W117.2-1974. A Free copy of "Arc Welding Safety" booklet E205 is available from the Lincoln Electric Company, 22801 St. Clair Avenue, Cleveland, Ohio 44117-1199.

**BE SURE THAT ALL INSTALLATION, OPERATION, MAINTENANCE AND REPAIR PROCEDURES ARE PERFORMED ONLY BY QUALIFIED INDIVIDUALS.**



### FOR ENGINE powered equipment.

1.a. Turn the engine off before troubleshooting and maintenance work unless the maintenance work requires it to be running.



1.b. Operate engines in open, well-ventilated areas or vent the engine exhaust fumes outdoors.



1.c. Do not add the fuel near an open flame welding arc or when the engine is running. Stop the engine and allow it to cool before refueling to prevent spilled fuel from vaporizing on contact with hot engine parts and igniting. Do not spill fuel when filling tank. If fuel is spilled, wipe it up and do not start engine until fumes have been eliminated.

1.d. Keep all equipment safety guards, covers and devices in position and in good repair. Keep hands, hair, clothing and tools away from V-belts, gears, fans and all other moving parts when starting, operating or repairing equipment.

1.e. In some cases it may be necessary to remove safety guards to perform required maintenance. Remove guards only when necessary and replace them when the maintenance requiring their removal is complete. Always use the greatest care when working near moving parts.



1.f. Do not put your hands near the engine fan. Do not attempt to override the governor or idler by pushing on the throttle control rods while the engine is running.

1.g. To prevent accidentally starting gasoline engines while turning the engine or welding generator during maintenance work, disconnect the spark plug wires, distributor cap or magneto wire as appropriate.



1.h. To avoid scalding, do not remove the radiator pressure cap when the engine is hot.

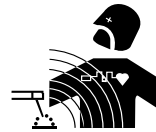

### ELECTRIC AND MAGNETIC FIELDS may be dangerous

2.a. Electric current flowing through any conductor causes localized Electric and Magnetic Fields (EMF). Welding current creates EMF fields around welding cables and welding machines

2.b. EMF fields may interfere with some pacemakers, and welders having a pacemaker should consult their physician before welding.

2.c. Exposure to EMF fields in welding may have other health effects which are now not known.

2.d. All welders should use the following procedures in order to minimize exposure to EMF fields from the welding circuit:

2.d.1. Route the electrode and work cables together - Secure them with tape when possible.

2.d.2. Never coil the electrode lead around your body.

2.d.3. Do not place your body between the electrode and work cables. If the electrode cable is on your right side, the work cable should also be on your right side.

2.d.4. Connect the work cable to the workpiece as close as possible to the area being welded.

2.d.5. Do not work next to welding power source.

Mar '95



## ELECTRIC SHOCK can kill.

- 3.a. The electrode and work (or ground) circuits are electrically "hot" when the welder is on. Do not touch these "hot" parts with your bare skin or wet clothing. Wear dry, hole-free gloves to insulate hands.
- 3.b. Insulate yourself from work and ground using dry insulation. Make certain the insulation is large enough to cover your full area of physical contact with work and ground.
- In addition to the normal safety precautions, if welding must be performed under electrically hazardous conditions (in damp locations or while wearing wet clothing; on metal structures such as floors, gratings or scaffolds; when in cramped positions such as sitting, kneeling or lying, if there is a high risk of unavoidable or accidental contact with the workpiece or ground) use the following equipment:**
- Semiautomatic DC Constant Voltage (Wire) Welder.
  - DC Manual (Stick) Welder.
  - AC Welder with Reduced Voltage Control.
- 3.c. In semiautomatic or automatic wire welding, the electrode, electrode reel, welding head, nozzle or semiautomatic welding gun are also electrically "hot".
- 3.d. Always be sure the work cable makes a good electrical connection with the metal being welded. The connection should be as close as possible to the area being welded.
- 3.e. Ground the work or metal to be welded to a good electrical (earth) ground.
- 3.f. Maintain the electrode holder, work clamp, welding cable and welding machine in good, safe operating condition. Replace damaged insulation.
- 3.g. Never dip the electrode in water for cooling.
- 3.h. Never simultaneously touch electrically "hot" parts of electrode holders connected to two welders because voltage between the two can be the total of the open circuit voltage of both welders.
- 3.i. When working above floor level, use a safety belt to protect yourself from a fall should you get a shock.
- 3.j. Also see Items 6.c. and 8.



## ARC RAYS can burn.

- 4.a. Use a shield with the proper filter and cover plates to protect your eyes from sparks and the rays of the arc when welding or observing open arc welding. Headshield and filter lens should conform to ANSI Z87.1 standards.
- 4.b. Use suitable clothing made from durable flame-resistant material to protect your skin and that of your helpers from the arc rays.
- 4.c. Protect other nearby personnel with suitable, non-flammable screening and/or warn them not to watch the arc nor expose themselves to the arc rays or to hot spatter or metal.



## FUMES AND GASES can be dangerous.

- 5.a. Welding may produce fumes and gases hazardous to health. Avoid breathing these fumes and gases. When welding, keep your head out of the fume. Use enough ventilation and/or exhaust at the arc to keep fumes and gases away from the breathing zone. **When welding with electrodes which require special ventilation such as stainless or hard facing (see instructions on container or MSDS) or on lead or cadmium plated steel and other metals or coatings which produce highly toxic fumes, keep exposure as low as possible and below Threshold Limit Values (TLV) using local exhaust or mechanical ventilation. In confined spaces or in some circumstances, outdoors, a respirator may be required. Additional precautions are also required when welding on galvanized steel.**
- 5.b. Do not weld in locations near chlorinated hydrocarbon vapors coming from degreasing, cleaning or spraying operations. The heat and rays of the arc can react with solvent vapors to form phosgene, a highly toxic gas, and other irritating products.
- 5.c. Shielding gases used for arc welding can displace air and cause injury or death. Always use enough ventilation, especially in confined areas, to insure breathing air is safe.
- 5.d. Read and understand the manufacturer's instructions for this equipment and the consumables to be used, including the material safety data sheet (MSDS) and follow your employer's safety practices. MSDS forms are available from your welding distributor or from the manufacturer.
- 5.e. Also see item 1.b.

Mar '95

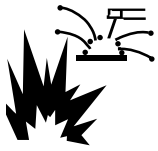

### WELDING SPARKS can cause fire or explosion.

6.a. Remove fire hazards from the welding area. If this is not possible, cover them to prevent the welding sparks from starting a fire.

Remember that welding sparks and hot materials from welding can easily go through small cracks and openings to adjacent areas. Avoid welding near hydraulic lines. Have a fire extinguisher readily available.

- 6.b. Where compressed gases are to be used at the job site, special precautions should be used to prevent hazardous situations. Refer to "Safety in Welding and Cutting" (ANSI Standard Z49.1) and the operating information for the equipment being used.
- 6.c. When not welding, make certain no part of the electrode circuit is touching the work or ground. Accidental contact can cause overheating and create a fire hazard.
- 6.d. Do not heat, cut or weld tanks, drums or containers until the proper steps have been taken to insure that such procedures will not cause flammable or toxic vapors from substances inside. They can cause an explosion even though they have been "cleaned". For information, purchase "Recommended Safe Practices for the Preparation for Welding and Cutting of Containers and Piping That Have Held Hazardous Substances", AWS F4.1 from the American Welding Society (see address above).
- 6.e. Vent hollow castings or containers before heating, cutting or welding. They may explode.
- 6.f. Sparks and spatter are thrown from the welding arc. Wear oil free protective garments such as leather gloves, heavy shirt, cuffless trousers, high shoes and a cap over your hair. Wear ear plugs when welding out of position or in confined places. Always wear safety glasses with side shields when in a welding area.
- 6.g. Connect the work cable to the work as close to the welding area as practical. Work cables connected to the building framework or other locations away from the welding area increase the possibility of the welding current passing through lifting chains, crane cables or other alternate circuits. This can create fire hazards or overheat lifting chains or cables until they fail.
- 6.h. Also see item 1.c.

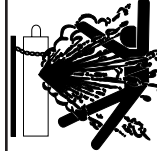

### CYLINDER may explode if damaged.

7.a. Use only compressed gas cylinders containing the correct shielding gas for the process used and properly operating regulators designed for the gas and pressure used. All hoses, fittings, etc. should be suitable for the application and maintained in good condition.

- 7.b. Always keep cylinders in an upright position securely chained to an undercarriage or fixed support.
- 7.c. Cylinders should be located:
  - Away from areas where they may be struck or subjected to physical damage.
  - A safe distance from arc welding or cutting operations and any other source of heat, sparks, or flame.
- 7.d. Never allow the electrode, electrode holder or any other electrically "hot" parts to touch a cylinder.
- 7.e. Keep your head and face away from the cylinder valve outlet when opening the cylinder valve.
- 7.f. Valve protection caps should always be in place and hand tight except when the cylinder is in use or connected for use.
- 7.g. Read and follow the instructions on compressed gas cylinders, associated equipment, and CGA publication P-1, "Precautions for Safe Handling of Compressed Gases in Cylinders," available from the Compressed Gas Association 1235 Jefferson Davis Highway, Arlington, VA 22202.



### FOR ELECTRICALLY powered equipment.

- 8.a. Turn off input power using the disconnect switch at the fuse box before working on the equipment.
- 8.b. Install equipment in accordance with the U.S. National Electrical Code, all local codes and the manufacturer's recommendations.
- 8.c. Ground the equipment in accordance with the U.S. National Electrical Code and the manufacturer's recommendations.

Mar '95

## PRÉCAUTIONS DE SÛRETÉ

Pour votre propre protection lire et observer toutes les instructions et les précautions de sûreté spécifiques qui paraissent dans ce manuel aussi bien que les précautions de sûreté générales suivantes:

### Sûreté Pour Soudage A L'Arc

1. Protégez-vous contre la secousse électrique:
  - a. Les circuits à l'électrode et à la pièce sont sous tension quand la machine à souder est en marche. Eviter toujours tout contact entre les parties sous tension et la peau nue ou les vêtements mouillés. Porter des gants secs et sans trous pour isoler les mains.
  - b. Faire très attention de bien s'isoler de la masse quand on soude dans des endroits humides, ou sur un plancher métallique ou des grilles métalliques, principalement dans les positions assis ou couché pour lesquelles une grande partie du corps peut être en contact avec la masse.
  - c. Maintenir le porte-électrode, la pince de masse, le câble de soudage et la machine à souder en bon et sûr état de fonctionnement.
  - d. Ne jamais plonger le porte-électrode dans l'eau pour le refroidir.
  - e. Ne jamais toucher simultanément les parties sous tension des porte-électrodes connectés à deux machines à souder parce que la tension entre les deux pinces peut être le total de la tension à vide des deux machines.
  - f. Si on utilise la machine à souder comme une source de courant pour soudage semi-automatique, ces précautions pour le porte-électrode s'appliquent aussi au pistolet de soudage.
2. Dans le cas de travail au dessus du niveau du sol, se protéger contre les chutes dans le cas où on recoit un choc. Ne jamais enrouler le câble-électrode autour de n'importe quelle partie du corps.
3. Un coup d'arc peut être plus sévère qu'un coup de soliel, donc:
  - a. Utiliser un bon masque avec un verre filtrant approprié ainsi qu'un verre blanc afin de se protéger les yeux du rayonnement de l'arc et des projections quand on soude ou quand on regarde l'arc.
  - b. Porter des vêtements convenables afin de protéger la peau de soudeur et des aides contre le rayonnement de l'arc.
  - c. Protéger l'autre personnel travaillant à proximité au soudage à l'aide d'écrans appropriés et non-inflammables.
4. Des gouttes de laitier en fusion sont émises de l'arc de soudage. Se protéger avec des vêtements de protection libres de l'huile, tels que les gants en cuir, chemise épaisse, pantalons sans revers, et chaussures montantes.
5. Toujours porter des lunettes de sécurité dans la zone de soudage. Utiliser des lunettes avec écrans latéraux dans les zones où l'on pique le laitier.

6. Eloigner les matériaux inflammables ou les recouvrir afin de prévenir tout risque d'incendie dû aux étincelles.
7. Quand on ne soude pas, poser la pince à une endroit isolé de la masse. Un court-circuit accidentel peut provoquer un échauffement et un risque d'incendie.
8. S'assurer que la masse est connectée le plus près possible de la zone de travail qu'il est pratique de le faire. Si on place la masse sur la charpente de la construction ou d'autres endroits éloignés de la zone de travail, on augmente le risque de voir passer le courant de soudage par les chaînes de levage, câbles de grue, ou autres circuits. Cela peut provoquer des risques d'incendie ou d'échauffement des chaînes et des câbles jusqu'à ce qu'ils se rompent.
9. Assurer une ventilation suffisante dans la zone de soudage. Ceci est particulièrement important pour le soudage de tôles galvanisées plombées, ou cadmiées ou tout autre métal qui produit des fumées toxiques.
10. Ne pas souder en présence de vapeurs de chlore provenant d'opérations de dégraissage, nettoyage ou pistolage. La chaleur ou les rayons de l'arc peuvent réagir avec les vapeurs du solvant pour produire du phosgène (gas fortement toxique) ou autres produits irritants.
11. Pour obtenir de plus amples renseignements sur la sûreté, voir le code "Code for safety in welding and cutting" CSA Standard W 117.2-1974.

## PRÉCAUTIONS DE SÛRETÉ POUR LES MACHINES À SOUDER À TRANSFORMATEUR ET À REDRESSEUR

1. Relier à la terre le châssis du poste conformément au code de l'électricité et aux recommandations du fabricant. Le dispositif de montage ou la pièce à souder doit être branché à une bonne mise à la terre.
2. Autant que possible, l'installation et l'entretien du poste seront effectués par un électricien qualifié.
3. Avant de faire des travaux à l'intérieur de poste, la débrancher à l'interrupteur à la boîte de fusibles.
4. Garder tous les couvercles et dispositifs de sûreté à leur place.

Mar. '93

# Thank You

for selecting a **QUALITY** product by Lincoln Electric. We want you to take pride in operating this Lincoln Electric Company product •• as much pride as we have in bringing this product to you!

## **Please Examine Carton and Equipment For Damage Immediately**

When this equipment is shipped, title passes to the purchaser upon receipt by the carrier. Consequently, Claims for material damaged in shipment must be made by the purchaser against the transportation company at the time the shipment is received.

Please record your equipment identification information below for future reference. This information can be found on your machine nameplate.

Product \_\_\_\_\_

Model Number \_\_\_\_\_

Code Number or Date Code \_\_\_\_\_

Serial Number \_\_\_\_\_

Date Purchased \_\_\_\_\_

Where Purchased \_\_\_\_\_

Whenever you request replacement parts or information on this equipment, always supply the information you have recorded above. The code number is especially important when identifying the correct replacement parts.

## **On-Line Product Registration**

- Register your machine with Lincoln Electric either via fax or over the Internet.

- For faxing: Complete the form on the back of the warranty statement included in the literature packet accompanying this machine and fax the form per the instructions printed on it.
- For On-Line Registration: Go to our **WEB SITE at [www.lincolnelectric.com](http://www.lincolnelectric.com)**. Choose "Quick Links" and then "Product Registration". Please complete the form and submit your registration.

**Read this Operators Manual completely** before attempting to use this equipment. Save this manual and keep it handy for quick reference. Pay particular attention to the safety instructions we have provided for your protection. The level of seriousness to be applied to each is explained below:

### **⚠ WARNING**

This statement appears where the information **must** be followed **exactly** to avoid **serious personal injury** or **loss of life**.

### **⚠ CAUTION**

This statement appears where the information **must** be followed to avoid **minor personal injury** or **damage to this equipment**.

|                                                                           | Page                   |
|---------------------------------------------------------------------------|------------------------|
| <b>Installation .....</b>                                                 | <b>Section A</b>       |
| Technical Specifications - POWER WAVE 355 .....                           | A-1                    |
| Safety Precautions.....                                                   | A-2                    |
| Select Suitable Location .....                                            | A-2                    |
| Stacking .....                                                            | A-2                    |
| Tilting.....                                                              | A-2                    |
| Input and Grounding Connections .....                                     | A-2                    |
| Power Cord Connection .....                                               | A-2                    |
| Undercarriage Mountings.....                                              | A-2                    |
| Output Cables, Connections and Limitations.....                           | A-3                    |
| Negative Electrode Polarity .....                                         | A-3                    |
| Voltage Sensing .....                                                     | A-3, A-4               |
| Power Wave to Semi-automatic Power Feed Wire Feeder Interconnections..... | A-4                    |
| Control Cable Specifications.....                                         | A-4                    |
| System Description.....                                                   | A-5                    |
| System Set-Up.....                                                        | A-6 thru A-8           |
| Welding with Multiple Power Waves.....                                    | A-9                    |
| I / O Receptacle Specifications.....                                      | A-10                   |
| Dip Switch Settings and Locations.....                                    | A-10                   |
| Control Board Dip Switch .....                                            | A-10                   |
| <b>Operation .....</b>                                                    | <b>Section B</b>       |
| Safety Precautions.....                                                   | B-1                    |
| General Description.....                                                  | B-1                    |
| Recommended Processes and Equipment .....                                 | B-1                    |
| Recommended Processes .....                                               | B-1                    |
| Required Equipment .....                                                  | B-2                    |
| Limitations .....                                                         | B-2                    |
| Duty Cycle and Time Period .....                                          | B-2                    |
| Case Front Controls .....                                                 | B-2, B-3               |
| Nominal Procedures.....                                                   | B-3                    |
| Fringe Procedures.....                                                    | B-3                    |
| Making a Weld .....                                                       | B-3                    |
| Welding Adjustment .....                                                  | B-3                    |
| Constant Voltage Welding.....                                             | B-4                    |
| Pulse Welding, Pulse on Pulse (GMAW) .....                                | B-4                    |
| Power Mode .....                                                          | B-5                    |
| <b>Accessories .....</b>                                                  | <b>Section C</b>       |
| Optional Equipment.....                                                   | C-1                    |
| Factory Installed.....                                                    | C-1                    |
| Field Installed.....                                                      | C-1                    |
| Compatible Lincoln Equipment                                              |                        |
| <b>Maintenance .....</b>                                                  | <b>Section D</b>       |
| Safety Precautions .....                                                  | D-1                    |
| Capacitor Discharge Procedure .....                                       | D-1                    |
| Routine Maintenance.....                                                  | D-1                    |
| Periodic Maintenance .....                                                | D-1                    |
| Calibration Specification.....                                            | D-1                    |
| <b>Troubleshooting .....</b>                                              | <b>Section E</b>       |
| How to use Troubleshooting Guide .....                                    | E-1                    |
| Using the Status LED to Troubleshoot System Problems .....                | E-2                    |
| Troubleshooting Guide.....                                                | E-3 thru E-7           |
| <b>Wiring Diagrams .....</b>                                              | <b>Section F-1, -2</b> |
| <b>Connection Diagram .....</b>                                           | <b>Section F-3</b>     |
| <b>Dimension Print.....</b>                                               | <b>Section F-4</b>     |
| <b>Parts Lists .....</b>                                                  | <b>P432</b>            |

## TECHNICAL SPECIFICATIONS - POWER WAVE F355i

## INPUT AC VOLTAGE &amp; DC OUTPUT

| Product Name     | Ordering Information | Input AC Voltage    | Rated DC Output Amps/Volts/Duty Cycle | Output Range (continuous) | Weight with Cord           | Dimensions HxWxD                                                                   |
|------------------|----------------------|---------------------|---------------------------------------|---------------------------|----------------------------|------------------------------------------------------------------------------------|
| POWER WAVE F355i | K2156-1              | 380-400/            | 350A / 34V / 60%                      | AMPS<br>5-425             | (100.0 lbs.)<br>(45.4 kg.) | 14.6" x 17.2" x 27.6"*<br>(371 x 437 x 701*)mm<br><br>* Includes Mounting Brackets |
|                  | K2156-2              | 415-460/<br>575     | 300A / 32V /100%                      |                           |                            |                                                                                    |
|                  |                      | 60/50 Hz<br>3 Phase |                                       |                           |                            |                                                                                    |

\* Overall Length without Mounting Brackets, 21.06" (535mm)

## POWER WAVE F355i INPUT CURRENT

Recommended Fuse Sizes Base On The U.S. National Electrical Code And Maximum Machine Outputs

| Input 50/60 Hz |        | Output                     |                           | Recommended      |           |
|----------------|--------|----------------------------|---------------------------|------------------|-----------|
| Voltage        | Phases | 300Amps @<br>32Volts(100%) | 350Amps @<br>34Volts(60%) | Line Cord<br>AWG | Fuse size |
| 380            | 3      | 23                         | 28                        | 10               | 40A       |
| 400            | 3      | 22                         | 27                        | 10               | 40A       |
| 415            | 3      | 22                         | 26                        | 10               | 40A       |
| 460            | 3      | 19                         | 23                        | 10               | 40A       |
| 575            | 3      | 16                         | 18                        | 10               | 30A       |

## OUTPUT CABLES, CONNECTIONS AND LIMITATIONS

Select The output cable size based upon the following chart.\*

Cable sizes for Combined Length of Electrode and Work Cable (Copper) 75C rated:

| DUTY CYCLE | CURRENT | LENGTH UP 200FT.(61m) |  | 200-250 FT. (61-76m) |
|------------|---------|-----------------------|--|----------------------|
| 100%       | 300     | 1/0                   |  | 1/0                  |
| 60%        | 350     | 1/0                   |  | 2/0                  |

\*Lincoln Electric recommends using a minimum of 2/0 welding cable for pulse welding.



## SAFETY PRECAUTIONS

### ⚠ WARNING



**ELECTRIC SHOCK** can kill.

- Turn the input power off at the disconnect switch before attempting to connect or disconnect input power lines, output cables or control cables
- Only qualified personnel should perform this installation.
- Connect the green lead of the power cord to ground per U.S.National Electrical Code.

## SELECT SUITABLE LOCATION

The Invertec POWER WAVE F355i will operate in harsh environments. Even so, it is important that simple preventative measures are followed in order to assure long life and reliable operation.

- The machine must be located where there is free circulation of clean air such that air movement in the back, out the sides and bottom will not be restricted.
- Dirt and dust that can be drawn into the machine should be kept to a minimum. Failure to observe these precautions can result in excessive operating temperatures and nuisance shutdown.
- Keep machine dry. Shelter from rain and snow. Do not place on wet ground or in puddles.
- **DO NOT MOUNT OVER COMBUSTIBLE SURFACES.**

### ⚠ CAUTION

Where there is a combustible surface directly under stationary or fixed electrical equipment, that surface shall be covered with a steel plate at least .06”(1.6mm) thick, which shall extend not less than 5.90”(150mm) beyond the equipment on all sides.

## STACKING

POWER WAVE F355i can not be stacked.

## TILTING

Place the machine directly on a secure, level surface or on a recommended undercarriage. The machine may topple over if this procedure is not followed.

## INPUT AND GROUNDING CONNECTIONS

- Only a qualified electrician should connect the Invertec POWER WAVE F355i. Installation should be made in accordance with the appropriate National Electrical Code, all local codes and the information detailed below.
- When received directly from the factory, multiple voltage machines are internally connected for 460VAC. If 460VAC is the desired input, then the machine may be connected to the power system without any setup required inside the machine.

- Initial 380VAC - 415VAC and 575VAC operation will require an Input voltage panel setup.
- Open the front door to access “A” lead.
- Move the "A" lead to the appropriate terminal.

### ⚠ CAUTION

- **Incorrect connection may result in equipment damage.**

## POWER CORD CONNECTION

A 7ft. power cord is provided and wired into the machine. Follow the power cord connection instructions.

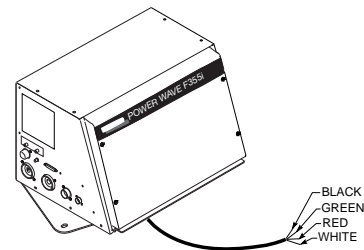

## Three Phase Input

Connect green lead to ground per National Electric Code.

Connect black, red and white leads to power.

POWER WAVE F355i



## OUTPUT CABLES, CONNECTIONS AND LIMITATIONS

Connect a work lead of sufficient size and length between the proper output terminal on the power source and the work. Be sure the connection to the work makes tight metal-to-metal electrical contact. To avoid interference problems with other equipment and to achieve the best possible operation, route all cables directly to the work or wire feeder. Avoid excessive lengths and do not coil excess cable.

### CAUTION

When using an inverter type power source like the Power Waves, use the largest welding (electrode and work) cables that are practical. At least 2/0 copper wire - even if the average output current would not normally require it. When pulsing, the pulse current can reach very high levels. Voltage drops can become excessive, leading to poor welding characteristics, if undersized welding cables are used.

Most welding applications run with the electrode being positive (+). For those applications, connect the electrode cable between the wire feeder and the positive (+) output Twist-Mate terminal on the power source. Connect the other end of the electrode cable to the wire drive feed plate. The electrode cable lug must be against the feed plate. Be sure the connection to the feed plate makes tight metal-to-metal electrical contact. The electrode cable should be sized according to the specifications given in the output cable connections section. Connect a work lead from the negative (-) power source output Twist-Mate terminal to the work piece. The work piece connection must be firm and secure, especially if pulse welding is planned.

For additional Safety information regarding the electrode and work cable set-up, See the standard "SAFETY INFORMATION" located in the front of the Instruction Manuals.

### CAUTION

**Excessive voltage drops caused by poor work piece connections often result in unsatisfactory welding performance.**

## NEGATIVE ELECTRODE POLARITY

When negative electrode polarity is required, such as in some Innershield applications, reverse the output connections at the power source (electrode cable to the negative (-) Twist-Mate terminal, and work cable to the positive (+) Twist-Mate terminal).

When operating with electrode polarity negative the "Electrode Sense Polarity" DIP switch must be set to the "Negative" position on the Wire Drive Feed Head PC Board. The default setting of the switch is positive electrode polarity. Set the Negative Polarity switch on Wire Feed Head PC board as follows:

### WARNING

#### ELECTRIC SHOCK can kill



- Turn the input power OFF at the disconnect switch or fuse box before working on this equipment.
- Do not touch electrically hot parts.

1. Turn off power to the power source at the disconnect switch.
2. Remove the front cover from the power source.
3. The feed head PC board is on the left side of the power source. Locate the 8-position DIP switch and look for switch 7 of the DIP switch. (See Figure A.1)
4. Using a pencil or other small object, slide the switch to the OFF position for positive electrode polarity. Conversely, slide the switch to the ON position for negative electrode polarity.
5. Replace the cover and screws. The PC board will "read" the switch at power up, and configure the work voltage sense lead appropriately.

## VOLTAGE SENSING

The best arc performance occurs when the PowerWaves have accurate data about the arc conditions. Depending upon the process, inductance within the electrode and work lead cables can influence the voltage apparent at the studs of the welder. Voltage sense leads improve the accuracy of the arc conditions and can have a dramatic effect on performance. Sense Lead Kits (K940-10, -25 or -50) are available for this purpose.

### CAUTION

**If the voltage sensing is enabled but the sense leads are missing, improperly connected, or if the electrode polarity switch is improperly configured, extremely high welding outputs may occur.**

The ELECTRODE sense lead (67) is built into the control cable, and is automatically enabled for all semi-automatic processes. The WORK sense lead (21) connects to the Power Wave at the four pin connector. By default the WORK voltage is monitored at the output stud in the POWER WAVE F355i. For more information on the WORK sense lead (21), see "Work Voltage Sensing" in the following paragraph.

Enable the voltage sense leads as follows:

**TABLE A.1**

| Process | Electrode Voltage Sensing 67 lead * | Work Voltage Sensing 21 lead |
|---------|-------------------------------------|------------------------------|
| GMAW    | 67 lead required                    | 21 lead optional             |
| GMAW-P  | 67 lead required                    | 21 lead optional             |
| FCAW    | 67 lead required                    | 21 lead optional             |
| GTAW    | Voltage sense at studs              | Voltage sense at studs       |
| GMAW    | Voltage sense at studs              | Voltage sense at studs       |
| SAW     | 67 lead required                    | 21 lead optional             |
| CAC-C   | Voltage sense at studs              | Voltage sense at studs       |

\* The electrode voltage 67 sense lead is integral to the control cable to the wire feeder.

### Work Voltage Sensing

The standard POWER WAVE F355i's default to the work stud (work sense lead disabled)

For processes requiring work voltage sensing, connect the (21) work voltage sense lead (K940) from the Power Wave work sense lead receptacle to the work piece. Attach the sense lead to the work piece as close to the weld as practical, but not in the return current path. Enable the work voltage sensing in the Power Wave as follows:

## WARNING

**ELECTRIC SHOCK can kill**



- Turn the input power OFF at the disconnect switch or fuse box before working on this equipment.

1. Turn off power to the power source at the disconnect switch.
2. Remove the wrap around cover from the power source.
3. The control board is on the center assembly facing the case front. Locate the 8-position DIP switch and look for switch 8 of the DIP switch (See Figure A.1).
4. Using a pencil or other small object, slide the switch to the OFF position if the work sense lead is NOT connected. Conversely, slide the switch to the ON position if the work sense lead is present.

5. Replace the wrap around and screws. The PC board will "read" the switch at power up, and configure the work voltage sense lead appropriately.

### ELECTRODE VOLTAGE SENSING

Enabling or disabling electrode voltage sensing is automatically configured through software. The 67 electrode sense lead is internal to the cable to the wire feeder and always connected when a wire feeder is present.



## CAUTION

**Important: The electrode polarity must be configured on the feed head PC board. Failure to do so may result in extremely high welding outputs.**

### POWER WAVE / POWER FEED WIRE FEEDER INTERCONNECTIONS

(See Section F-2 for Connection Diagram)

Connect the control cable between the power source and wire feeder. The wire feeder connection on the Power Wave F355i is the 14-pin connector located on the left side of the machine. The control cable is keyed and polarized to prevent improper connection.

### CONTROL CABLE SPECIFICATIONS

It is recommended that genuine Lincoln control cables be used at all times. Lincoln cables are specifically designed for the communication and power needs of the Power Wave / Power Feed system.



## CAUTION

**The use of non-standard cables, especially in lengths greater than 25 feet, can lead to communication problems (system shutdowns), poor motor acceleration (poor arc starting) and low wire driving force (wire feeding problems).**

### HIGH SPEED GEAR BOX

Changing the ratio requires a gear change and a PC board switch change. The Power Feed Wire Feeders are shipped with both high speed and a low speed gears. As shipped from the factory, the low speed (high torque) gear is installed on the feeder. To change Gear ratio see Power Feed 10/R Instruction Manual.

**WARNING**

**ELECTRIC SHOCK can kill.**



- Turn the input power OFF at the disconnect switch or fuse box before working on this equipment.

1. Set the High/Low switch code on Feed Head PC board as follows:
2. Turn off power to the power source at the disconnect switch.
3. Remove the front cover from the power source.
4. The wire feed head board is on the left side of the power source. Locate the 8-position DIP switch and look for position 8 of the DIP switch. (See Figure A.1)
5. Using a pencil or other small object, slide the switch to the OFF position, when the low speed gear is installed. Conversely, slide the switch to the ON position when the high speed gear is installed.
6. Replace the cover and screws. The PC board will “read” the switch at power up, automatically adjusting all control parameters for the speed range selected.

**DIP Switch Settings and Locations**

(See Figure A.1)

DIP switches on the P.C. Boards allow for custom configuration of the Power Wave. To access the DIP switches:

**WARNING**

- Turn off power at the disconnect switch.
- Remove the top four screws securing the front access panel.
- Adjust the DIP switches as necessary.
- Replace the panel and screws, and restore power.

**Control Board DIP Switch:**

- switch 1 = Object Instance LSB 1 (see table 1)
- switch 2 = Object Instance MSB 2 (see table 1)
- switch 3 = Equipment Group 1 Select
- switch 4 = Equipment Group 2 Select
- switch 5 = Equipment Group 3 Select
- switch 6 = Equipment Group 4 Select
- switch 7 = reserved for future use
- switch 8 = work sense lead
- 1 LEASE SIGNIFICANT BIT
- 2 MOST SIGNIFICANT BIT

| switch 8 | work sense lead                |
|----------|--------------------------------|
| off      | work sense lead not connected* |
| on       | work sense lead connected      |

**Feed Head Board DIP Switch:**

- switch 1 = Object Instance LSB (see table 1)
- switch 2 = Object Instance MSB (see table 1)
- switch 3 = Equipment Group 1 Select
- switch 4 = Equipment Group 2 Select
- switch 5 = Equipment Group 3 Select
- switch 6 = Equipment Group 4 Select
- switch 7 = negative polarity switch

| switch 7 | electrode polarity |
|----------|--------------------|
| off      | positive *         |
| on       | negative           |

switch 8 = high speed gear

| switch 8 | wire drive gear  |
|----------|------------------|
| off      | low speed gear * |
| on       | high speed gear  |

**TABLE 1**

**Object Instance**

| switch 2 | switch 1 | Instance |
|----------|----------|----------|
| off      | off      | 0 *      |
| off      | on       | 1        |
| on       | off      | 2        |
| on       | on       | 3        |

**\*Factory Setting**

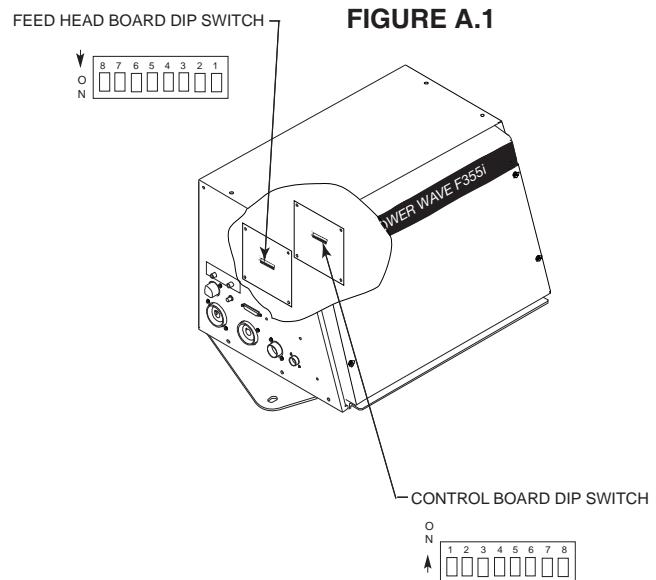

LOCATION OF DIP SWITCHES IN MACHINE

**WELDING WITH MULTIPLE POWER WAVES**

**I / O RECEPTACLE SPECIFICATIONS**

**CAUTION**

Special care must be taken when more than one Power Wave is welding simultaneously on a single part. Arc blow and arc interference may occur or be magnified.

Each power source requires a work lead from the work stud to the welding fixture. Do not combine all of the work leads into one lead. The welding travel directions should be in the direction moving away from the work lead as shown below. Connect all of the work sense leads from each power source to the work piece at the end of the weld. (See Figure A.2)

For the best results when pulse welding, set the wire size and wire feed speed the same for all the Power Waves. When these parameters are identical, the pulsing frequency will be the same, helping to stabilize the arcs.

Every welding gun requires a separate shielding gas regulator for proper flow rate and shielding gas coverage.

Do not attempt to supply shielding gas for two or more guns from only one regulator.

If an anti-spatter system is in use then each gun must have its own anti-spatter system.

| 14-Pin Robotic Wire Feeder Connector |      |                             |
|--------------------------------------|------|-----------------------------|
| Pin                                  | Lead | Function                    |
| A                                    | 539  | Motor +                     |
| B                                    | 541  | Motor -                     |
| C                                    | 521  | Solenoid +                  |
| D                                    | 522  | Solenoid common             |
| E                                    | 845  | Tach 2A Differential Signal |
| F                                    | 847  | Single Tach input           |
| G                                    | 841  | +15V Tach Supply            |
| H                                    | 844  | Tach common                 |
| I                                    | Open | Reserved for future use     |
| J                                    | GND  | Shielding drain             |
| K                                    | 842  | Tach 1A Differential Signal |
| L                                    | 843  | Tach 1B Differential Signal |
| M                                    | 846  | Tach 2B Differential Signal |
| N                                    | 67   | Electrode Sense (67)        |

| VOLTAGE SENSE RECEPTACLE |       |                         |
|--------------------------|-------|-------------------------|
| PIN                      | LEAD# | FUNCTION                |
| 3                        | 21    | Work Voltage Sense      |
| 1                        | 67    | Electrode Voltage Sense |

| RS232 RECEPTACLE |       |                |
|------------------|-------|----------------|
| PIN              | LEAD# | FUNCTION       |
| 2                | 253   | RS232 Receive  |
| 3                | 254   | RS232 Transmit |
| 4                | #     | Pin5           |
| 5                | #     | Pin4           |
| 6                | # #   | Pin20          |
| 20               | # #   | Pin6           |
| 7                | 251   | RS232 Common   |

| WIRE FEEDER RECEPTACLE* |       |                         |
|-------------------------|-------|-------------------------|
| PIN                     | LEAD# | FUNCTION                |
| A                       | 153   | Communication Bus L     |
| B                       | 154   | Communication Bus H     |
| C                       | 67    | Electrode Voltage Sense |
| D                       | 52    | Ovdc -                  |
| E                       | 51    | +40vdc +                |

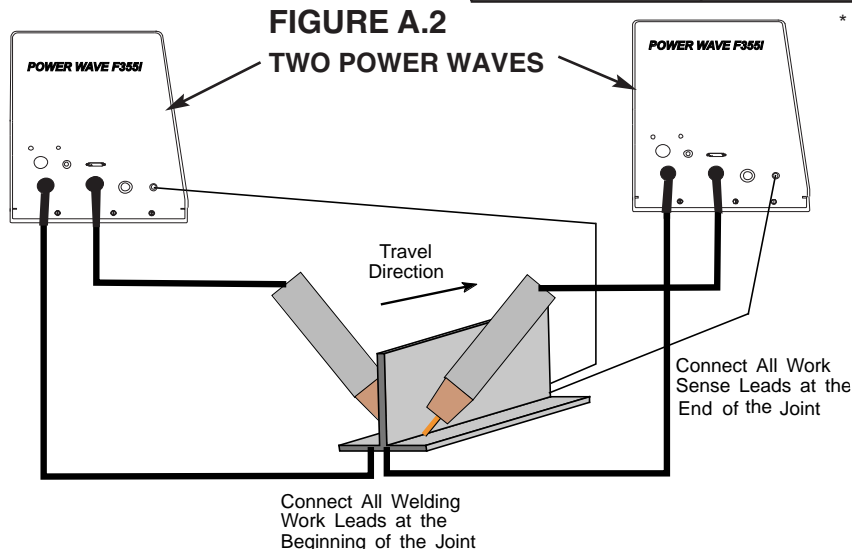

\* Not on Codes 10916 or below.

POWER WAVE F355i



## SAFETY PRECAUTIONS

Read this entire section of operating instructions before operating the machine.



### WARNING

#### ELECTRIC SHOCK can kill.



- Unless using cold feed feature, when feeding with gun trigger, the electrode and drive mechanism are always electrically energized and could remain energized several seconds after the welding ceases.

- Do not touch electrically live parts or electrodes with your skin or wet clothing.
- Insulate yourself from the work and ground.
- Always wear dry insulating gloves.

#### FUMES AND GASES can be dangerous.



- Keep your head out of fumes.
- Use ventilation or exhaust to remove fumes from breathing zone.

#### WELDING SPARKS can cause fire or explosion.

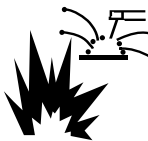

- Keep flammable material away.
- Do not weld on containers that have held combustibles.

#### ARC RAYS can burn.



- Wear eye, ear, and body protection.

Observe additional guidelines detailed in the beginning of this manual.

## GENERAL DESCRIPTION

The Power Wave Robotic power source is designed to be a part of a modular, multi-process welding system. Depending on configuration, it can support constant current, constant voltage, and pulse welding modes.

The Power Wave power source is designed to be used with the Robotic family of Power Feed wire feeders, operating as a system. Each component in the system has special circuitry to "talk with" the other system components, so each component (power source, wire feeder Robotic Controller) knows what the other is doing at all times. These components communicate with Arc Link.

The POWER WAVE F355i is a high performance, digitally controlled inverter welding power source capable of complex, high-speed waveform control. Properly equipped, it can support the GMAW, GMAW-P and FCAW processes. It carries an output rating of 350 Amps, 34 Volts at 60% duty cycle and 300 Amps, 32 volts at 100% duty cycle.

## RECOMMENDED PROCESSES AND EQUIPMENT

### RECOMMENDED PROCESSES

The POWER WAVE F355i can be set up in a number of configurations, some requiring optional equipment or welding programs. Each machine is factory preprogrammed with multiple welding procedures, typically including GMAW, GMAW-P and FCAW for a variety of materials, including mild steel, stainless steel, cored wires, and aluminum.

The POWER WAVE F355i is recommended for Robotic welding with the Fanuc R-J3iB.

- This Power Wave F355i is not recommended for processes other than those listed.

### REQUIRED EQUIPMENT

Any Arc Link compatible semi-automatic wire feeding equipment. Specifically, the Power Feed 10 Robotic Wire drive.

**LIMITATIONS**

- Only Arc Link compatible Power Feed automatic wire feeders and users interfaces may be used. Other Lincoln wire feeders or non-Lincoln wire feeders cannot be used.
- **POWER WAVE F355i Output Limitations**  
The POWER WAVE F355i will support maximum average output current of 350 Amps @ 60% duty cycle.

**DUTY CYCLE AND TIME PERIOD**

The duty cycle is based upon a ten minute period. A 60% duty cycle represents 6 minutes of welding and 4 minutes of idling in a ten minute period.

**CONNECTOR STATUS LIGHTS** (Per Fig B.1)

**1. STATUS LIGHT:** A two color light that indicates system errors. Normal operation is a steady green light. Error conditions are indicated, **per Table B.1.**

**NOTE:** The POWER WAVE F355i status light will flash green, and sometimes red and green, for up to one minute when the machine is first turned on. This is a normal situation as the machine goes through a self test at power up.

- 2. HIGH TEMPERATURE LIGHT** (thermal overload): A yellow light that comes on when an over temperature situation occurs. Output is disabled and the fan continues to run, until the machine cools down. When cool, the light goes out and output is enabled.
- 3. CB1 WIRE FEEDER CIRCUIT BREAKER:** Protects 40 volt DC wire feeder power supply.

**TABLE B.1**

| Light Condition           | Meaning                                                                                                                                                                                                                                                                                                                                                                                                                                                                                                                                                                   |
|---------------------------|---------------------------------------------------------------------------------------------------------------------------------------------------------------------------------------------------------------------------------------------------------------------------------------------------------------------------------------------------------------------------------------------------------------------------------------------------------------------------------------------------------------------------------------------------------------------------|
| Steady Green              | System OK. Power source communicating normally with wire feeder and its components.                                                                                                                                                                                                                                                                                                                                                                                                                                                                                       |
| Blinking Green            | Occurs during a reset, and indicates the POWER WAVE F355i is mapping (identifying) each component in the system. Normal for first 1-10 seconds after power is turned on, or if the system configuration is changed during operation                                                                                                                                                                                                                                                                                                                                       |
| Alternating Green and Red | Non-recoverable system fault. If the PS Status light is flashing any combination of red and green, errors are present in the POWER WAVE F355i. <b>Read the error code before the machine is turned off.</b><br><br>Error Code interpretation through the Status light is detailed in the Service Manual. Individual code digits are flashed in red with a long pause between digits. If more than one code is present, the codes will be separated by a green light.<br><br>To clear the error, turn power source off, and back on to reset. See Troubleshooting Section. |
| Steady Red                | Non recoverable hardware fault. Generally indicates nothing is connected to the POWER WAVE F355i wire feeder receptacle. See Trouble Shooting Section.                                                                                                                                                                                                                                                                                                                                                                                                                    |
| Blinking Red              | Not applicable.                                                                                                                                                                                                                                                                                                                                                                                                                                                                                                                                                           |

**Figure B.1**

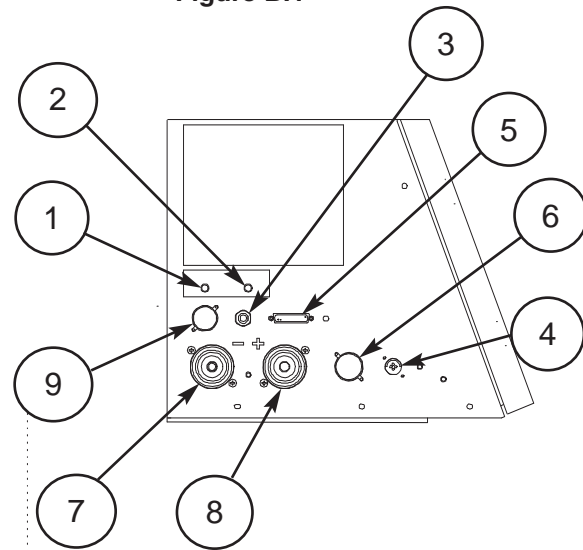

**CASE FRONT LAYOUT  
POWER WAVE F355i**

- 4. LEAD CONNECTOR (SENSE LEAD)**
- 5. DIAGNOSTIC CONNECTOR (RS-232)**
- 6. WIRE FEEDER RECEPTACLE (14-PIN)**
- 7. NEGATIVE TWIST- MATE TERMINAL**
- 8. POSITIVE TWIST- MATE TERMINAL**
- 9. WIRE FEEDER RECEPTACLE (5 PIN) NOT ON CODES 10916 OR BELOW.**

## NOMINAL PROCEDURES

The Power Wave is designed to operate with 3/4" electrode stick-out for CV and Pulse processes.

## FRINGE PROCEDURES

Excessively short or long electrode stick-outs may function only on a limited basis, if at all.

## MAKING A WELD

### WARNING

**The serviceability of a product or structure utilizing the welding programs is and must be the sole responsibility of the builder/user. Many variables beyond the control of The Lincoln Electric Company affect the results obtained in applying these programs. These variables include, but are not limited to, welding procedure, plate chemistry and temperature, weldment design, fabrication methods and service requirements. The available range of a welding program may not be suitable for all applications, and the build/user is and must be solely responsible for welding program selection.**

First, consider the desired welding process and the part to be welded. Choose an electrode material, diameter, shielding gas and process (GMAW, GMAW-P, etc.)

Second, find the program in the welding software that best matches the desired welding process. The standard software shipped with the Power Waves encompasses a wide range of common processes and will meet most needs. If a special welding program is desired, contact the local Lincoln Electric sales representative.

To make a weld, the Power Wave needs to know the desired welding parameters. The Power Feed (PF) family of feeders communicate settings to the Power Wave through control cable connection. Arc length, wire feed speed, arc control, etc. are all communicated digitally via the control cable.

#### • WFS / AMPS:

In synergic welding modes (synergic CV, pulse GMAW) WFS (wire feed speed) is the dominant control parameter, controlling all other variables. The user adjusts WFS according to factors such as weld size, penetration requirements, heat input, etc. The Power Wave then uses the WFS setting to adjust its output characteristics (output voltage, output current) according to pre-programmed settings contained in the Power Wave.

In non-synergic modes, the WFS control behaves more like a conventional CV power source where WFS and voltage are independent adjustments. Therefore to maintain the arc characteristics, the operator must adjust the voltage to compensate for any changes made to the WFS.

#### • VOLTS / TRIM:

In constant voltage modes (synergic CV, standard CV) the control adjusts the welding voltage.

In pulse synergic welding modes (pulse GMAW only) the user can change the Trim setting to adjust the arc length. It is adjustable from 0.500 to 1.500. A Trim setting of 1.000 is a good starting point for most conditions.

#### • WELDING MODE

Selecting a welding mode determines the output characteristics of the Power Wave power source. For a more complete description of the welding modes available in the Power Wave and for a complete set of weld modes programmed into the Power Wave at the factory, refer to the weld mode print included with the Power Wave.

#### • ARC CONTROL

Also known as Inductance or Wave Control. Allows operator to vary the arc characteristics from "soft" to "harsh" in all weld modes. It is adjustable from -10.0 to +10.0, with a nominal setting of 00.0 (The nominal setting of 00.0 may be displayed as OFF on some Power Feed wire feeder control panels). See the Welding Mode descriptions, below, for detailed explanations of how the Arc Control affects each mode.

## CONSTANT VOLTAGE WELDING

### Synergic CV:

For each wire feed speed, a corresponding voltage is preprogrammed into the machine through special software at the factory. The nominal preprogrammed voltage is the best average voltage for a given wire feed speed, but may be adjusted to preference. When the wire feed speed changes, the Power Wave automatically adjusts the voltage level correspondingly to maintain similar arc characteristics throughout the WFS range.



**Non Synergic CV:**

This type of CV mode behaves more like a conventional CV power source. Voltage and WFS are independent adjustments. Therefore to maintain the arc characteristics, the operator must adjust the voltage to compensate for any changes made to the WFS.

**All CV Modes:**

Arc Control, often referred to as wave control, adjusts the inductance of the wave shape. The wave control adjustment is similar to the "pinch" function in that it is inversely proportional to inductance. Therefore, increasing wave control greater than 0.0 results in a harsher, colder arc while decreasing the wave control to less than 0.0 provides a softer, hotter arc. (See Figure B.2)

**FIGURE B.2**  
**CURRENT WAVE FORM (CV)**

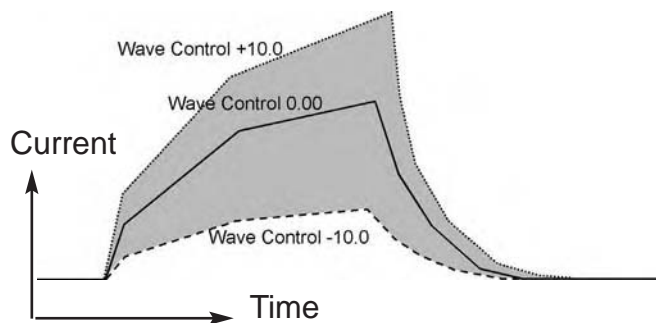
**PULSE WELDING**

Pulse welding procedures are set by controlling an overall "arc length" variable. When pulse welding, the arc voltage is highly dependent upon the waveform. The peak current, back ground current, rise time, fall time and pulse frequency all affect the voltage. The exact voltage for a given wire feed speed can only be predicted when all the pulsing waveform parameters are known. Using a preset voltage becomes impractical, and instead the arc length is set by adjusting "trim".

Trim adjusts the arc length and ranges from 0.50 to 1.50, with a nominal value of 1.00. Trim values greater than 1.00 increase the arc length, while values less than 1.00 decrease the arc length.

Most pulse welding programs are synergic. As the wire feed speed is adjusted, the Power Wave will automatically recalculate the waveform parameters to maintain similar arc properties.

The Power Wave utilizes "adaptive control" to compensate for changes in electrical stick-out while welding. (Electrical stick-out is the distance from the contact tip to the work piece.) The Power Wave waveforms are optimized for a 0.75" (19mm) stick-out. The adaptive behavior supports a range of stickouts from 0.50" (13mm) to 1.25" (32mm). At very low or high wire feed speeds, the adaptive range may be less due to reaching physical limitations of the welding process.

Arc Control, often referred to as wave control, in pulse programs usually adjusts the focus or shape of the arc. Wave control values greater than 0.0 increase the pulse frequency while decreasing the background current, resulting in a tight, stiff arc best for high speed sheet metal welding. Wave control values less than 0.0 decrease the pulse frequency while increasing the background current, for a soft arc good for out-of-position welding. (See Figure B.3)

**FIGURE B.3**  
**CURRENT WAVE FORM (PULSE)**

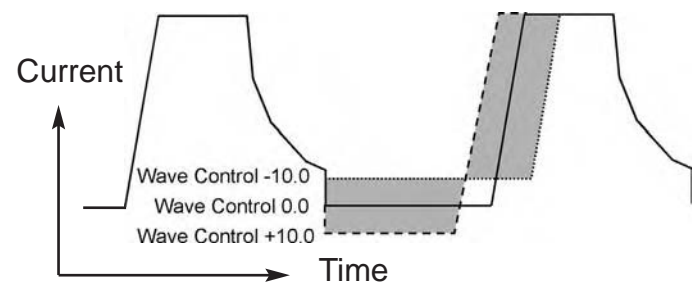
**PULSE-ON-PULSE™ (GMAW-PP)**

Pulse on Pulse™ is a Lincoln process specifically designed for use in welding relatively thin (less than 1/4" thick) aluminum. It gives weld beads with very consistent uniform ripple.

In Pulse on Pulse modes, two distinct pulse types are used, instead of the single pulse type normally used in GMAW-P. A number of high energy pulses are used to obtain spray transfer and transfer metal across the arc. Such pulses are shown in Figure B.4. After a number "N" of such pulses, depending on the wire feed speed used, an identical number "N" of low energy pulses are performed. These low energy pulses, shown in Figure B.4, do not transfer any filler metal across the arc and help to cool the arc and keep the heat input low.

**FIGURE B.4**

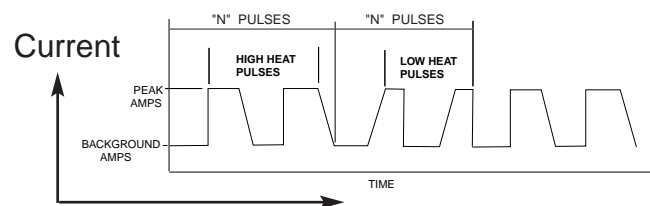

**POWER WAVE F355i**



The Peak Current, Background Current, and Frequency are identical for the high energy and low energy pulses. In addition to cooling the weld down, the major effect of the low energy pulses is that they form a weld ripple. Since they occur at very regular time intervals, the weld bead obtained is very uniform with a very consistent ripple pattern. In fact, the bead has its best appearance if no oscillation of the welding gun ("whipping") is used. (See Figure B.5)

FIGURE B.5

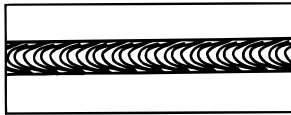

When Arc Control is used in the Pulse on Pulse modes, it does the same things it does in the other pulsed modes: decreasing the Arc Control decreases the droplet transfer and weld deposition rate. Increasing the Arc Control increases the droplet transfer and weld deposition rate. Since Arc Control varies weld droplet transfer rate, the Arc Control can be used to vary the ripple spacing in the weld bead.

**POWER MODE™**

The Power Mode™ process was developed by Lincoln to maintain a stable and smooth arc at low procedure settings which are needed to weld thin metal without pop-outs or burning-through. For aluminum welding, it provides excellent control and the ability to maintain constant arc length. This results in improved welding performance in two primary types of applications.

- Short Arc MIG at low procedure settings.
- Aluminum MIG welding.

Power Mode™ is a method of high speed regulation of the output power whenever an arc is established. It provides a fast response to changes in the arc. The higher the Power Mode Setting, the longer the arc. If a welding procedure is not established, the best way to determine the Power Mode Setting is by experimentation until the desired output result is established.

In the Power Mode two variables need to be set:

- Wire Feed Speed
- Power Mode Trim

Setting up a Power Mode procedure is similar to setting a CV MIG procedure. Select a shielding gas appropriate for a short arc process.

- For steel, use 75/25 Ar/CO<sub>2</sub> shield gas.
- For stainless, select a Helium blend Tri-Mix.
- For aluminum, use 100% Ar.

Start by setting the wire feed speed based upon material thickness and appropriate travel speed. Then adjust the Volts/Trim knob as follows:

- For steel, listen for the traditional "frying egg" sound of a good short-arc MIG procedure to know you have the process set correctly.
- For aluminum, simply adjust the Volts/Trim knob until the desired arc length is obtained.

Note the Volts/Trim display is simply a relative number and DOES NOT correspond to voltage.

Some procedure recommendations appear in Table B.1.

**Recommended Welding Procedures for Power Mode - Table B.1**

| MATERIAL                                       | Aluminum 4043                 | Aluminum 5356                 | Mild Steel           | Mild Steel               | Mild Steel           | Mild Steel               | Mild Steel           | Mild Steel               | Mild Steel           | Stainless Steel | Stainless Steel |
|------------------------------------------------|-------------------------------|-------------------------------|----------------------|--------------------------|----------------------|--------------------------|----------------------|--------------------------|----------------------|-----------------|-----------------|
| WIRE                                           | E4043                         | E5356                         | L56                  | L56                      | L56                  | L56                      | L56                  | L56                      | L56                  | E308L           | E308L           |
| WIRE SIZE                                      | 0.035                         | 0.035                         | 0.025                | 0.025                    | 0.030                | 0.030                    | 0.035                | 0.035                    | 0.030                | 0.030           | 0.035           |
| GAS                                            | 100% Ar.                      | 100% Ar.                      | 100% CO <sub>2</sub> | 75/25 Ar/CO <sub>2</sub> | 100% CO <sub>2</sub> | 75/25 Ar/CO <sub>2</sub> | 100% CO <sub>2</sub> | 75/25 Ar/CO <sub>2</sub> | 100% CO <sub>2</sub> | Tri-mix         | Tri-mix         |
| MATERIAL THICKNESS<br>WFS / POWER MODE SETTING | 22 ga.                        |                               | Not Recommended      | 100 / 0.8                | Not Recommended      | 90 / 1.0                 |                      |                          |                      |                 |                 |
|                                                | 20 ga.                        |                               | 120 / 1.0            | 120 / 1.0                | 100 / 0.7            | 100 / 1.0                |                      |                          | 80 / 1.5             | 50 / 0.5        |                 |
|                                                | 18 ga.                        |                               | 140 / 1.7            | 140 / 1.5                | 110 / 1.5            | 110 / 1.5                | 100 / 2.5            | 100 / 2.5                | 110 / 2.0            | 110 / 2.0       |                 |
|                                                | 16 ga.                        |                               | 190 / 2.0            | 190 / 2.0                | 125 / 2.0            | 125 / 2.0                | 125 / 3.0            | 125 / 3.0                | 140 / 2.5            | 130 / 2.7       |                 |
|                                                | 14 ga.                        | 400 / 2.0                     | 400 / 2.5            | 260 / 3.0                | 260 / 3.0            | 160 / 2.3                | 160 / 2.3            | 160 / 3.8                | 160 / 3.5            | 210 / 3.0       | 190 / 3.5       |
|                                                | 12 ga.                        |                               |                      | 330 / 5.0                | 330 / 4.5            | 230 / 3.5                | 230 / 3.5            | 200 / 5.0                | 200 / 4.5            | 270 / 5.0       | 230 / 6.0       |
|                                                | 10 ga.                        | 500 / 7.0                     | 500 / 7.0            |                          |                      | 300 / 6.0                | 300 / 6.0            | 240 / 6.5                | 240 / 7.0            | 325 / 6.5       | 300 / 7.0       |
|                                                | 3/16                          | 570 / 9.0                     | 600 / 7.8            |                          |                      | 400 / 7.5                | 400 / 7.0            |                          |                      |                 |                 |
| 1/4                                            | 700 / 9.1                     | 700 / 8.5                     |                      |                          |                      |                          |                      |                          |                      |                 |                 |
| COMMENTS                                       | Not Recommended below 400 WFS | Not Recommended below 400 WFS |                      |                          |                      |                          |                      |                          |                      |                 |                 |

---

**OPTIONAL EQUIPMENT****FACTORY INSTALLED**

None Available.

**FIELD INSTALLED**

K940-Work Voltage Sense Lead Kit

K1796-Coaxial Welding Cable-(Requires Adapter K2176-1)

K2176-1 Twist-mate to Lug Adapters

Welding Cable Connectors:

K852-70 1/0-2/0 CABLE

K852-95 2/0-3/0 CABLE

**COMPATIBLE LINCOLN EQUIPMENT**

Power Feed 10 Robotic Wire Drive

K1785-[ ] 14 Pin to 14 Pin Fanuc

(Control Cable, 12 Ft., 16 Ft. or 25 Ft. lengths)

**COMMUNICATION INTERFACE**

K2436-1 (Not on Codes 10916 or below)

## SAFETY PRECAUTIONS

### ⚠ WARNING



**ELECTRIC SHOCK can kill.**

- Do not touch electrically live parts or electrode with skin or wet clothing.
- Insulate yourself from work and ground
- Always wear dry insulating gloves.

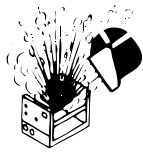

**EXPLODING PARTS can cause injury.**

- Failed parts can explode or cause other parts to explode when power is applied.
- Always wear a face shield and long sleeves when servicing.

See additional warning information throughout this Operator's Manual

## CAPACITOR DISCHARGE PROCEDURE

1. Obtain a power resistor (25 ohms, 25 watts).
2. Hold resistor body with electrically insulated glove. **DO NOT TOUCH TERMINALS.** Connect the resistor terminals across the two studs in the position shown. Hold in each position for 1 second. Repeat for all four capacitors.

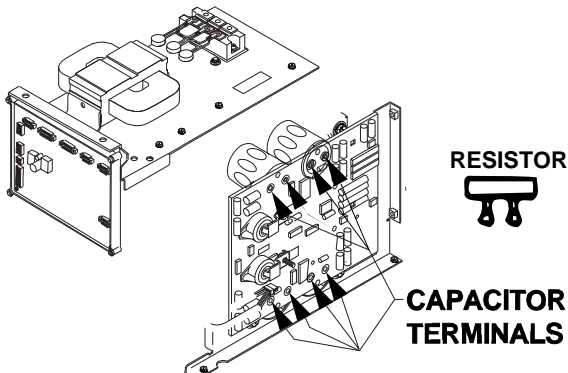

3. Use a DC voltmeter to check that voltage is not present across the terminals on all four capacitors.

## ROUTINE MAINTENANCE

Routine maintenance consists of periodically blowing out the machine, using a low pressure airstream, to remove accumulated dust and dirt from the intake and outlet louvers, and the cooling channels in the machine.

## PERIODIC MAINTENANCE

Calibration of the POWER WAVE F355i is critical to its operation. Generally speaking the calibration will not need adjustment. However, neglected or improperly calibrated machines may not yield satisfactory weld performance. To ensure optimal performance, the calibration of output Voltage and Current should be checked yearly.

## CALIBRATION SPECIFICATION

Output Voltage and Current are calibrated at the factory. Generally speaking the machine calibration will not need adjustment. However, if the weld performance changes, or the yearly calibration check reveals a problem, contact the Lincoln Electric Company for the calibration software utility.

The calibration procedure itself requires the use of a resistance load, and certified actual meters for voltage and current. The accuracy of the calibration will be directly affected by the accuracy of the measuring equipment you use. Detailed instructions are available with the utility.

---

**HOW TO USE TROUBLESHOOTING GUIDE****⚠ WARNING**

Service and Repair should only be performed by Lincoln Electric Factory Trained Personnel. Unauthorized repairs performed on this equipment may result in danger to the technician and machine operator and will invalidate your factory warranty. For your safety and to avoid Electrical Shock, please observe all safety notes and precautions detailed throughout this manual.

This Troubleshooting Guide is provided to help you locate and repair possible machine malfunctions. Simply follow the three-step procedure listed below.

**Step 1. LOCATE PROBLEM (SYMPTOM).**

Look under the column labeled “PROBLEM (SYMPTOMS)”. This column describes possible symptoms that the machine may exhibit. Find the listing that best describes the symptom that the machine is exhibiting.

**Step 2. POSSIBLE CAUSE.**

The second column labeled “POSSIBLE CAUSE” lists the obvious external possibilities that may contribute to the machine symptom.

**Step 3. RECOMMENDED COURSE OF ACTION**

This column provides a course of action for the Possible Cause, generally it states to contact your local Lincoln Authorized Field Service Facility.

If you do not understand or are unable to perform the Recommended Course of Action safely, contact your local Lincoln Authorized Field Service Facility.

**⚠ CAUTION**

If for any reason you do not understand the test procedures or are unable to perform the tests/repairs safely, contact your **Local Lincoln Authorized Field Service Facility** for technical troubleshooting assistance before you proceed.

---

## USING THE STATUS LED TO TROUBLESHOOT SYSTEM PROBLEMS

The Power Wave / Power Feed are best diagnosed as a system. Each component (power source, user interface, and feed head) has a status light, and when a problem occurs it is important to note the condition of each.

Included in this section is information about the power source Status LED, and some basic troubleshooting charts for both machine and weld performance.

The STATUS LIGHT is a two color light that indicates system errors. Normal operation is a steady green light. Error conditions are indicated in the following chart.

NOTE: The POWER WAVE F355i status light will flash green, and sometimes red and green, for up to one minute when the machine is first turned on. This is a normal situation as the machine goes through a self test at power up.

| Light Condition           | Meaning                                                                                                                                                                                                                                                                                                                                                                                                                                                                                                                                                                          |
|---------------------------|----------------------------------------------------------------------------------------------------------------------------------------------------------------------------------------------------------------------------------------------------------------------------------------------------------------------------------------------------------------------------------------------------------------------------------------------------------------------------------------------------------------------------------------------------------------------------------|
| Steady Green              | System OK. Power source communicating normally with wire feeder and its components.                                                                                                                                                                                                                                                                                                                                                                                                                                                                                              |
| Blinking Green            | Occurs during a reset, and indicates the POWER WAVE F355i is mapping (identifying) each component in the system. Normal for first 1-10 seconds after power is turned on, or if the system configuration is changed during operation                                                                                                                                                                                                                                                                                                                                              |
| Alternating Green and Red | <p>Non-recoverable system fault. If the PS Status light is flashing any combination of red and green, errors are present in the POWER WAVE F355i. <b>Read the error code before the machine is turned off.</b></p> <p>Error Code interpretation through the Status light is detailed in the Service Manual. Individual code digits are flashed in red with a long pause between digits. If more than one code is present, the codes will be separated by a green light.</p> <p>To clear the error, turn power source off, and back on to reset. See Troubleshooting Section.</p> |
| Steady Red                | Non recoverable hardware fault. Generally indicates nothing is connected to the POWER WAVE F355i wire feeder receptacle. See Trouble Shooting Section.                                                                                                                                                                                                                                                                                                                                                                                                                           |
| Blinking Red              | Not applicable.                                                                                                                                                                                                                                                                                                                                                                                                                                                                                                                                                                  |

Observe all Safety Guidelines detailed throughout this manual

### ERROR CODES FOR THE POWER WAVE

The following is a list of possible error codes that the POWER WAVE F355i can output via the status light (see "Troubleshooting the Power Wave / Power Feed System Using the Status LED." If connected to a PF-10/11 these error codes will generally be accompanied by an "Err 006" or "Err 100" on the user interface display.

|    | <b>Error Code #</b>            | <b>Indication</b>                                                                                                                                                                                                                                                                                          |
|----|--------------------------------|------------------------------------------------------------------------------------------------------------------------------------------------------------------------------------------------------------------------------------------------------------------------------------------------------------|
| 11 | CAN communication bus off.     | Probably due to excessive number of communication errors.                                                                                                                                                                                                                                                  |
| 12 | User Interface time out error. | UI is no longer responding to the Power Source. The most likely cause is a fault/bad connection in the communication leads or control cable.                                                                                                                                                               |
| 21 | Unprogrammed Weld Mode.        | Contact the Service Department for instructions on reloading the Welding Software.                                                                                                                                                                                                                         |
| 22 | Empty Weld Table.              | Contact the Service Department for instructions on reloading the Welding Software.                                                                                                                                                                                                                         |
| 23 | Weld Table checksum error.     | Contact the Service Department for instructions on reloading the Welding Software.                                                                                                                                                                                                                         |
| 31 | Primary overcurrent error.     | Excessive Primary current present. May be related to a short in the main transformer or output rectifier.                                                                                                                                                                                                  |
| 32 | Capacitor "A" under voltage    | Low voltage on the main capacitors. May be caused by improper input configuration.                                                                                                                                                                                                                         |
| 33 | Capacitor "B" under voltage    | When accompanied by an overvoltage error on the same side, it indicates no capacitor voltage present on that side, and is usually the result of an open or short in the primary side of the machine.                                                                                                       |
| 34 | Capacitor "A" over voltage     | Excess voltage on the main capacitors. May be caused by improper input configuration.                                                                                                                                                                                                                      |
| 35 | Capacitor "B" over voltage     | When accompanied by an under voltage error on the same side, it indicates no capacitor voltage present on that side, and is usually the result of an open or short in the primary side of the machine.                                                                                                     |
| 36 | Thermal error                  | Indicates over temperature. Usually accompanied by Thermal LED. Check fan operation. Be sure process does not exceed duty cycle limit of the machine.                                                                                                                                                      |
| 37 | Soft start error               | Capacitor precharge failed. Usually accompanied by codes 32-35.                                                                                                                                                                                                                                            |
| 41 | Secondary overcurrent error    | The secondary (weld) current limit has been exceeded. When this occurs the machine output will phase back to 100 amps, typically resulting in a condition referred to as "noodle welding"<br><br>NOTE: The secondary limit is 570 amps for the standard stud, and 325 amps for all single phase operation. |
| 43 | Capacitor delta error          | The maximum voltage difference between the main capacitors has been exceeded. May be accompanied by errors 32-35.                                                                                                                                                                                          |
|    | Other                          | Error codes that contain three or four digits are defined as fatal errors. These codes generally indicate internal errors on the Control Board. If cycling the input power on the machine does not clear the error, try reloading the operating system. If this fails, replace the control board.          |

### CAUTION

If for any reason you do not understand the test procedures or are unable to perform the tests/repairs safely, contact your **Local Lincoln Authorized Field Service Facility** for technical troubleshooting assistance before you proceed.

POWER WAVE F355i



Observe all Safety Guidelines detailed throughout this manual

### TROUBLESHOOTING GUIDE

Observe Safety Guidelines detailed in the beginning of this manual.

| PROBLEMS (SYMPTOMS)                                                                     | POSSIBLE CAUSE                                                                                                                                                                                                                                                                                                                                                                                                                                                                                                             | RECOMMENDED COURSE OF ACTION                                                                                                                                         |
|-----------------------------------------------------------------------------------------|----------------------------------------------------------------------------------------------------------------------------------------------------------------------------------------------------------------------------------------------------------------------------------------------------------------------------------------------------------------------------------------------------------------------------------------------------------------------------------------------------------------------------|----------------------------------------------------------------------------------------------------------------------------------------------------------------------|
| <b>OUTPUT PROBLEMS</b>                                                                  |                                                                                                                                                                                                                                                                                                                                                                                                                                                                                                                            |                                                                                                                                                                      |
| Major physical or electrical damage is evident when the sheet metal covers are removed. | 1. Contact your local authorized Lincoln Electric Field Service facility for technical assistance.                                                                                                                                                                                                                                                                                                                                                                                                                         | If all recommended possible areas of misadjustments have been checked and the problem persists, <b>contact your local Lincoln Authorized Field Service Facility.</b> |
| Input fuses keep blowing, or input breaker keeps tripping.                              | <ol style="list-style-type: none"> <li>1. Make certain that fuses or breakers are properly sized. See Installation section of this manual for recommended fuse and breaker sizes.</li> <li>2. Welding procedure is drawing too much output current, or duty cycle is too high. Reduce output current, duty cycle, or both.</li> <li>3. There is internal damage to the power source. Contact an authorized Lincoln Electric Service facility.</li> </ol>                                                                   |                                                                                                                                                                      |
| Machine will not power up (no lights, no fan, etc.)                                     | <ol style="list-style-type: none"> <li>1. Make certain that the Power to the Power Wave F355i is on.</li> <li>2. Circuit Breaker CB1 (on Case Front) may have opened. Reset. An over load on the 40V Wire Feeder supply may cause this to trip.</li> <li>3. Circuit breaker CB3 (in reconnect area) may have opened. Reset. Also, check input voltage selection, below.</li> <li>4. Input voltage selection made improperly. Power down, check input voltage reconnect according to diagram on reconnect cover.</li> </ol> |                                                                                                                                                                      |



### CAUTION

If for any reason you do not understand the test procedures or are unable to perform the tests/repairs safely, contact your local authorized Lincoln Electric Field Service Facility for technical assistance.

POWER WAVE F355i





Observe all Safety Guidelines detailed throughout this manual

## TROUBLESHOOTING GUIDE

Observe Safety Guidelines detailed in the beginning of this manual.

| PROBLEMS<br>(SYMPTOMS)                    | POSSIBLE<br>CAUSE                                                                                                                                                                                                                                                                                                                                                                                                                                                                                                                                                                                                                                                                                                                                                                                                                              | RECOMMENDED<br>COURSE OF ACTION                                                                                                                                             |
|-------------------------------------------|------------------------------------------------------------------------------------------------------------------------------------------------------------------------------------------------------------------------------------------------------------------------------------------------------------------------------------------------------------------------------------------------------------------------------------------------------------------------------------------------------------------------------------------------------------------------------------------------------------------------------------------------------------------------------------------------------------------------------------------------------------------------------------------------------------------------------------------------|-----------------------------------------------------------------------------------------------------------------------------------------------------------------------------|
| <b>OUTPUT PROBLEMS</b>                    |                                                                                                                                                                                                                                                                                                                                                                                                                                                                                                                                                                                                                                                                                                                                                                                                                                                |                                                                                                                                                                             |
| Thermal LED is lit.                       | <ol style="list-style-type: none"> <li>1. Fan thermostat has opened. Check for proper fan operation. (Fan should run whenever output power is on.) Check for material blocking intake or exhaust louvers, or for excessive dirt clogging cooling channels in machine. Blow air in rear louvers to remove dirt around the fan.</li> <li>2. Secondary rectifier or Choke thermostat has opened. After machine has cooled, reduce load, duty cycle, or both. Check for material blocking intake or exhaust louvers.</li> <li>3. DC Bus PC board thermostat has opened check for excessive load on 40VDC supply.</li> </ol>                                                                                                                                                                                                                        |                                                                                                                                                                             |
| Machine won't weld, can't get any output. | <ol style="list-style-type: none"> <li>1. Input voltage is too low or too high. Make certain that input voltage is proper, according to the Rating Plate located on the rear of the machine.</li> <li>2. If the Thermal LED is also lit, see "Yellow Thermal LED is Lit" section.</li> <li>3. Primary current limit has been exceeded. Possible short in output circuit. Turn machine off. Remove all loads from the output of the machine. Turn back on. If condition persists, turn power off, and contact an authorized Lincoln Electric Field Service facility.</li> <li>4. This problem will normally be accompanied by an error code. Error codes are displayed as a series of red and green flashes by the status light. See "Troubleshooting the Power Wave / Power Feed System Using the Status LED" section of this text.</li> </ol> | <p>If all recommended possible areas of misadjustments have been checked and the problem persists, <b>contact your local Lincoln Authorized Field Service Facility.</b></p> |



### CAUTION

If for any reason you do not understand the test procedures or are unable to perform the tests/repairs safely, contact your local authorized Lincoln Electric Field Service Facility for technical assistance.

POWER WAVE F355i



Observe all Safety Guidelines detailed throughout this manual

## TROUBLESHOOTING GUIDE

Observe Safety Guidelines detailed in the beginning of this manual.

| PROBLEMS<br>(SYMPTOMS)                                                                                                                                | POSSIBLE<br>CAUSE                                                                                                                                                                                                                                                                                                                                                                                             | RECOMMENDED<br>COURSE OF ACTION                                                                                                                                             |
|-------------------------------------------------------------------------------------------------------------------------------------------------------|---------------------------------------------------------------------------------------------------------------------------------------------------------------------------------------------------------------------------------------------------------------------------------------------------------------------------------------------------------------------------------------------------------------|-----------------------------------------------------------------------------------------------------------------------------------------------------------------------------|
| <b>OUTPUT PROBLEMS</b>                                                                                                                                |                                                                                                                                                                                                                                                                                                                                                                                                               |                                                                                                                                                                             |
| Machine often “noodle welds” (output is limited to approximately 100 amps) when running a particular procedure, especially a procedure with high WFS. | <ol style="list-style-type: none"> <li>1. Secondary current limit has been exceeded, and the machine has phased back to protect itself.</li> <li>2. Adjust procedure or reduce load to lower current draw from the machine.</li> </ol>                                                                                                                                                                        | <p>If all recommended possible areas of misadjustments have been checked and the problem persists, <b>contact your local Lincoln Authorized Field Service Facility.</b></p> |
| Machine won't produce full output.                                                                                                                    | <ol style="list-style-type: none"> <li>1. Input voltage may be too low, limiting output capability of the power source. Make certain that the input voltage is proper, according to the Rating Plate located on the rear of the machine.</li> <li>2. Secondary current or voltage not be properly calibrated. Check values displayed on the Power Feed 10/11 verses readings on an external meter.</li> </ol> |                                                                                                                                                                             |
| For no apparent reason, the welding characteristics have changed.                                                                                     | <ol style="list-style-type: none"> <li>1. Check for proper Wire Feed Speed setting. In CV MIG and FCAW modes, check for proper Voltage setting. In the MIG/MAG pulse modes, check the Trim setting. These controls are on the wire feeder.</li> <li>2. Check for proper shielding gas mix and flow.</li> <li>3. Check for loose or faulty weld cables and cable connections.</li> </ol>                       |                                                                                                                                                                             |
| The Power Wave is triggered to weld, but there is no output.                                                                                          | <ol style="list-style-type: none"> <li>1. Check for fault signals from the I/O connector. Possible faults are lack of water flow/ water flow turned off.</li> </ol>                                                                                                                                                                                                                                           |                                                                                                                                                                             |



### CAUTION

If for any reason you do not understand the test procedures or are unable to perform the tests/repairs safely, contact your local authorized Lincoln Electric Field Service Facility for technical assistance.

POWER WAVE F355i



Observe all Safety Guidelines detailed throughout this manual

| PROBLEMS<br>(SYMPTOMS)                      | POSSIBLE<br>CAUSE                                                                                                                                                                                                                                                                                                                                                                                                                                                                                                                                                                                   | RECOMMENDED<br>COURSE OF ACTION                                                                                                                                             |
|---------------------------------------------|-----------------------------------------------------------------------------------------------------------------------------------------------------------------------------------------------------------------------------------------------------------------------------------------------------------------------------------------------------------------------------------------------------------------------------------------------------------------------------------------------------------------------------------------------------------------------------------------------------|-----------------------------------------------------------------------------------------------------------------------------------------------------------------------------|
| General degradation of the weld performance | <ol style="list-style-type: none"> <li>1. Check for feeding problems, bad connections, excessive loops in cabling, etc.</li> <li>2. Verify weld mode is correct for processes.</li> <li>3. The power source may require calibration.</li> <li>4. Check the actual current displayed on the Power Feed 10 vs. actual current measured via external meter.</li> <li>5. Check the actual voltage displayed on the Power Feed 10 vs. actual voltage measured via external meter.</li> <li>6. Check the actual WFS displayed on the Power Feed 10 vs. actual WFS measured via external meter.</li> </ol> | <p>If all recommended possible areas of misadjustments have been checked and the problem persists, <b>contact your local Lincoln Authorized Field Service Facility.</b></p> |
| Excessively long and erratic arc.           | <ol style="list-style-type: none"> <li>1. Check for proper configuration and implementation of voltage sensing circuits.</li> </ol>                                                                                                                                                                                                                                                                                                                                                                                                                                                                 |                                                                                                                                                                             |
| The feeder will not cold inch wire.         | <ol style="list-style-type: none"> <li>1. Check for fault signals from the I/O connector. Possible faults are lack of water flow/ water cooler turned off.</li> </ol>                                                                                                                                                                                                                                                                                                                                                                                                                               |                                                                                                                                                                             |
| Arc loss fault on robot.                    | <ol style="list-style-type: none"> <li>1. Possibly caused by wire feeding problem.</li> <li>2. Problem - Conduit leading to the wire feeder has bends or twists, which can reduce the wire feed speed. Solution - Remove bends and twists from conduit.</li> <li>3. Problem – Conduit leading up to the wire feeder from the wire reel is too long. Solution – Use a shorter length of conduit.</li> </ol>                                                                                                                                                                                          |                                                                                                                                                                             |

 **CAUTION**

If for any reason you do not understand the test procedures or are unable to perform the tests/repairs safely, contact your **Local Lincoln Authorized Field Service Facility** for technical troubleshooting assistance before you proceed.

POWER WAVE F355i



WIRING DIAGRAM POWER WAVE F355i FOR CODE 10916

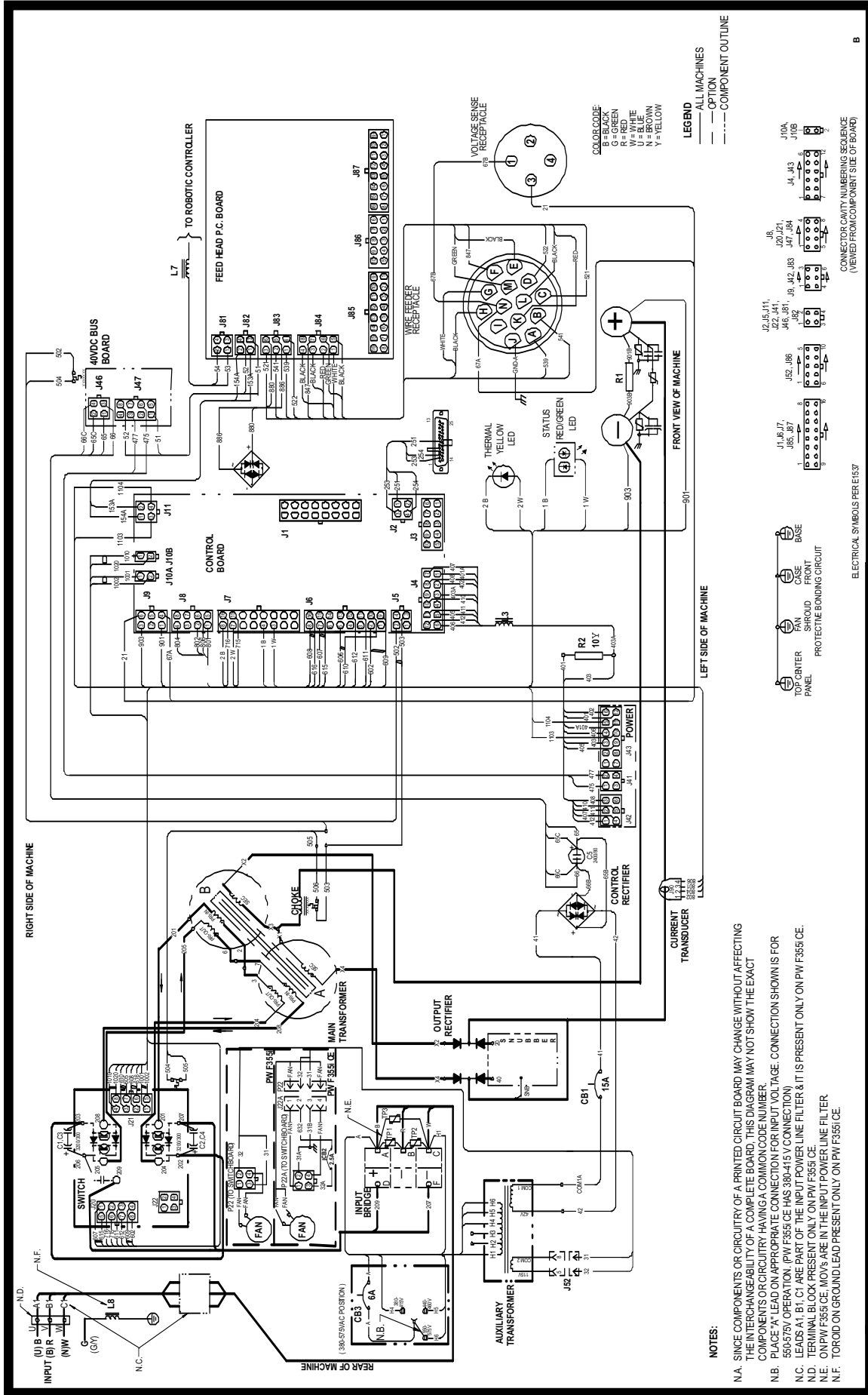

G4146

NOTE: This diagram is for reference only. It may not be accurate for all machines covered by this manual. The specific diagram for a particular code is pasted inside the machine on one of the enclosure panels. If the diagram is illegible, write to the Service Department for a replacement. Give the equipment code number.

WIRING DIAGRAM POWER WAVE F355i FOR CODE 11251

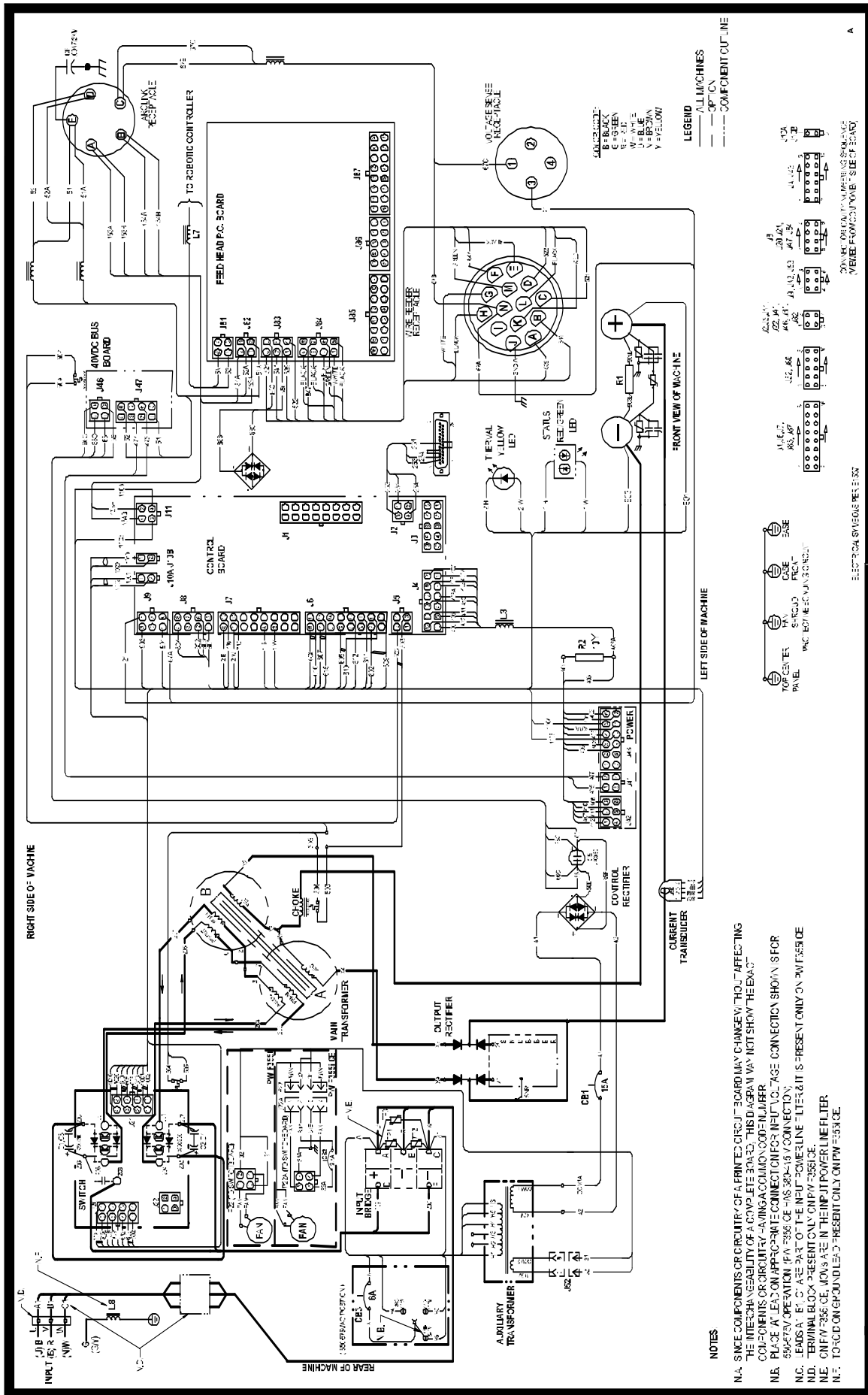

G5375

NOTE: This diagram is for reference only. It may not be accurate for all machines covered by this manual. The specific diagram for a particular code is pasted inside the machine on one of the enclosure panels. If the diagram is illegible, write to the Service Department for a replacement. Give the equipment code number.

Connection Diagram Semi-automatic "Simple System"

(Electrode Positive, CV / Pulse Configuration shown)

SEE SECTION A-4, Power Wave / Power Feed Wire

Feeder Interconnections

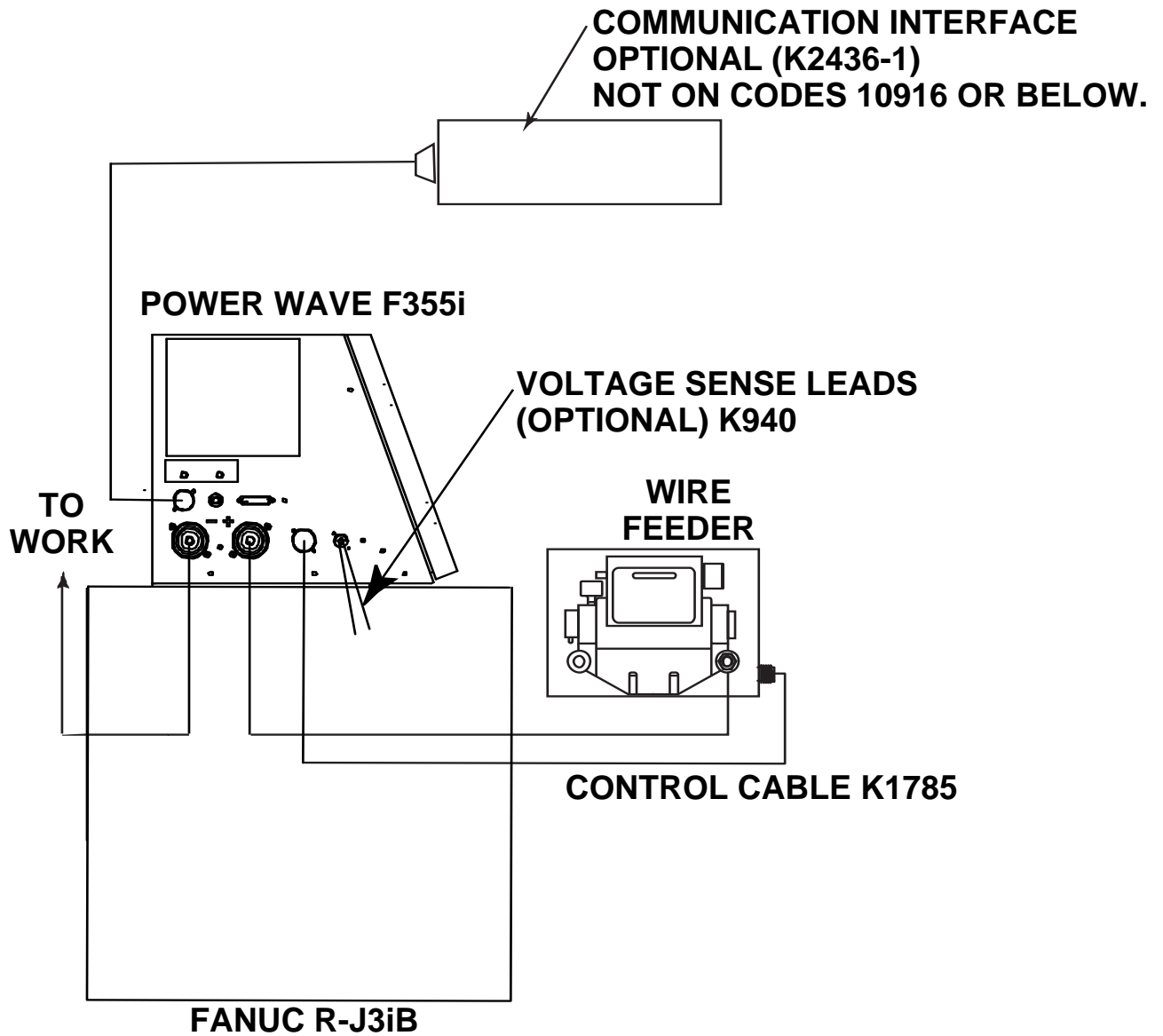

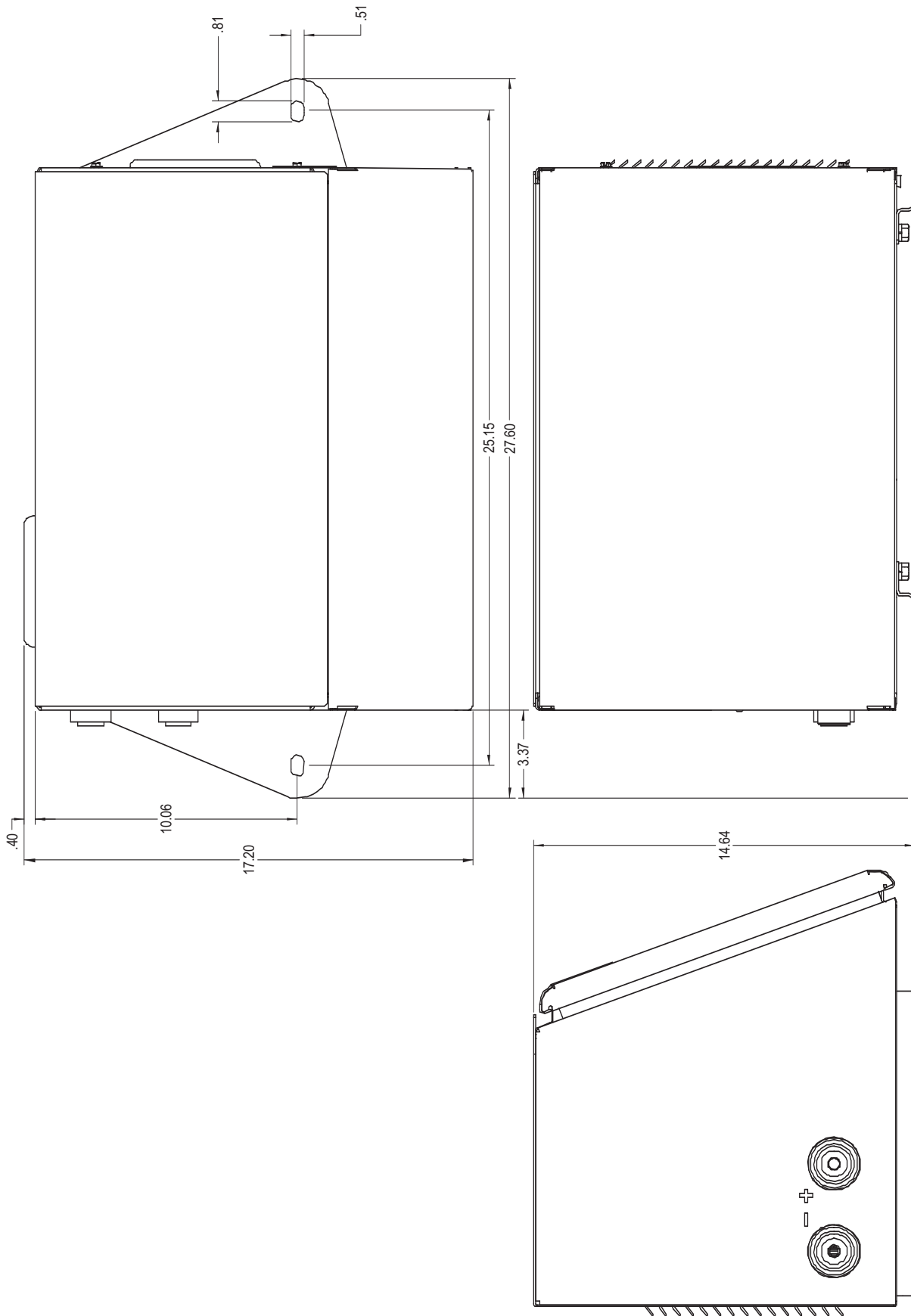

A M19982

POWER WAVE F355i



# NOTES

---

POWER WAVE F355i





# NOTES

---

POWER WAVE F355i



|                                                                                  |                                                                                                                                                                                                                         |                                                                                                                 |                                                                                                     |
|----------------------------------------------------------------------------------|-------------------------------------------------------------------------------------------------------------------------------------------------------------------------------------------------------------------------|-----------------------------------------------------------------------------------------------------------------|-----------------------------------------------------------------------------------------------------|
|  |                                                                                                                                         |                                |                   |
| <b>WARNING</b>                                                                   | <ul style="list-style-type: none"> <li>● Do not touch electrically live parts or electrode with skin or wet clothing.</li> <li>● Insulate yourself from work and ground.</li> </ul>                                     | <ul style="list-style-type: none"> <li>● Keep flammable materials away.</li> </ul>                              | <ul style="list-style-type: none"> <li>● Wear eye, ear and body protection.</li> </ul>              |
| Spanish<br><b>AVISO DE PRECAUCION</b>                                            | <ul style="list-style-type: none"> <li>● No toque las partes o los electrodos bajo carga con la piel o ropa mojada.</li> <li>● Aíslese del trabajo y de la tierra.</li> </ul>                                           | <ul style="list-style-type: none"> <li>● Mantenga el material combustible fuera del área de trabajo.</li> </ul> | <ul style="list-style-type: none"> <li>● Protéjase los ojos, los oídos y el cuerpo.</li> </ul>      |
| French<br><b>ATTENTION</b>                                                       | <ul style="list-style-type: none"> <li>● Ne laissez ni la peau ni des vêtements mouillés entrer en contact avec des pièces sous tension.</li> <li>● Isolez-vous du travail et de la terre.</li> </ul>                   | <ul style="list-style-type: none"> <li>● Gardez à l'écart de tout matériel inflammable.</li> </ul>              | <ul style="list-style-type: none"> <li>● Protégez vos yeux, vos oreilles et votre corps.</li> </ul> |
| German<br><b>WARNUNG</b>                                                         | <ul style="list-style-type: none"> <li>● Berühren Sie keine stromführenden Teile oder Elektroden mit Ihrem Körper oder feuchter Kleidung!</li> <li>● Isolieren Sie sich von den Elektroden und dem Erdboden!</li> </ul> | <ul style="list-style-type: none"> <li>● Entfernen Sie brennbares Material!</li> </ul>                          | <ul style="list-style-type: none"> <li>● Tragen Sie Augen-, Ohren- und Körperschutz!</li> </ul>     |
| Portuguese<br><b>ATENÇÃO</b>                                                     | <ul style="list-style-type: none"> <li>● Não toque partes elétricas e electrodos com a pele ou roupa molhada.</li> <li>● Isole-se da peça e terra.</li> </ul>                                                           | <ul style="list-style-type: none"> <li>● Mantenha inflamáveis bem guardados.</li> </ul>                         | <ul style="list-style-type: none"> <li>● Use proteção para a vista, ouvido e corpo.</li> </ul>      |
| Japanese<br><b>注意事項</b>                                                          | <ul style="list-style-type: none"> <li>● 通電中の電気部品、又は溶材にヒフやぬれた布で触れないこと。</li> <li>● 施工物やアースから身体が絶縁されている様にして下さい。</li> </ul>                                                                                                | <ul style="list-style-type: none"> <li>● 燃えやすいものの側での溶接作業は絶対にしてはなりません。</li> </ul>                                | <ul style="list-style-type: none"> <li>● 目、耳及び身体に保護具をして下さい。</li> </ul>                              |
| Chinese<br><b>警告</b>                                                             | <ul style="list-style-type: none"> <li>● 皮肤或湿衣物切勿接触带电部件及焊条。</li> <li>● 使你自已与地面和工作件绝缘。</li> </ul>                                                                                                                        | <ul style="list-style-type: none"> <li>● 把一切易燃物品移离工作场所。</li> </ul>                                              | <ul style="list-style-type: none"> <li>● 佩戴眼、耳及身体劳动保护用具。</li> </ul>                                 |
| Korean<br><b>위험</b>                                                              | <ul style="list-style-type: none"> <li>● 전도체나 용접봉을 젖은 형갑 또는 피부로 절대 접촉치 마십시오.</li> <li>● 모재와 접지를 접촉치 마십시오.</li> </ul>                                                                                                    | <ul style="list-style-type: none"> <li>● 인화성 물질을 접근시키지 마십시오.</li> </ul>                                         | <ul style="list-style-type: none"> <li>● 눈, 귀와 몸에 보호장구를 착용하십시오.</li> </ul>                          |
| Arabic<br><b>تحذير</b>                                                           | <ul style="list-style-type: none"> <li>● لا تلمس الاجزاء التي يسري فيها التيار الكهربائي أو الألكترود بجسد الجسم أو بالملابس المبللة بالماء.</li> <li>● ضع عازلا على جسمك خلال العمل.</li> </ul>                        | <ul style="list-style-type: none"> <li>● ضع المواد القابلة للاشتعال في مكان بعيد.</li> </ul>                    | <ul style="list-style-type: none"> <li>● ضع أدوات وملابس واقية على عينيك وأذنيك وجسمك.</li> </ul>   |

**READ AND UNDERSTAND THE MANUFACTURER'S INSTRUCTION FOR THIS EQUIPMENT AND THE CONSUMABLES TO BE USED AND FOLLOW YOUR EMPLOYER'S SAFETY PRACTICES.**

**SE RECOMIENDA LEER Y ENTENDER LAS INSTRUCCIONES DEL FABRICANTE PARA EL USO DE ESTE EQUIPO Y LOS CONSUMIBLES QUE VA A UTILIZAR, SIGA LAS MEDIDAS DE SEGURIDAD DE SU SUPERVISOR.**

**LISEZ ET COMPRENEZ LES INSTRUCTIONS DU FABRICANT EN CE QUI REGARDE CET EQUIPMENT ET LES PRODUITS A ETRE EMPLOYES ET SUIVEZ LES PROCEDURES DE SECURITE DE VOTRE EMPLOYEUR.**

**LESEN SIE UND BEFOLGEN SIE DIE BETRIEBSANLEITUNG DER ANLAGE UND DEN ELEKTRODENEINSATZ DES HERSTELLERS. DIE UNFALLVERHÜTUNGSVORSCHRIFTEN DES ARBEITGEBERS SIND EBENFALLS ZU BEACHTEN.**

|                                                                                                                                                                                               |                                                                                                                                                                                              |                                                                                                                                                                 |                                       |
|-----------------------------------------------------------------------------------------------------------------------------------------------------------------------------------------------|----------------------------------------------------------------------------------------------------------------------------------------------------------------------------------------------|-----------------------------------------------------------------------------------------------------------------------------------------------------------------|---------------------------------------|
|                                                                                                                                                                                               |                                                                                                                                                                                              |                                                                                                                                                                 |                                       |
| <ul style="list-style-type: none"> <li>● Keep your head out of fumes.</li> <li>● Use ventilation or exhaust to remove fumes from breathing zone.</li> </ul>                                   | <ul style="list-style-type: none"> <li>● Turn power off before servicing.</li> </ul>                                                                                                         | <ul style="list-style-type: none"> <li>● Do not operate with panel open or guards off.</li> </ul>                                                               | <b>WARNING</b>                        |
| <ul style="list-style-type: none"> <li>● Los humos fuera de la zona de respiración.</li> <li>● Mantenga la cabeza fuera de los humos. Utilice ventilación o aspiración para gases.</li> </ul> | <ul style="list-style-type: none"> <li>● Desconectar el cable de alimentación de poder de la máquina antes de iniciar cualquier servicio.</li> </ul>                                         | <ul style="list-style-type: none"> <li>● No operar con panel abierto o guardas quitadas.</li> </ul>                                                             | Spanish<br><b>AVISO DE PRECAUCION</b> |
| <ul style="list-style-type: none"> <li>● Gardez la tête à l'écart des fumées.</li> <li>● Utilisez un ventilateur ou un aspirateur pour ôter les fumées des zones de travail.</li> </ul>       | <ul style="list-style-type: none"> <li>● Débranchez le courant avant l'entretien.</li> </ul>                                                                                                 | <ul style="list-style-type: none"> <li>● N'opérez pas avec les panneaux ouverts ou avec les dispositifs de protection enlevés.</li> </ul>                       | French<br><b>ATTENTION</b>            |
| <ul style="list-style-type: none"> <li>● Vermeiden Sie das Einatmen von Schweißrauch!</li> <li>● Sorgen Sie für gute Be- und Entlüftung des Arbeitsplatzes!</li> </ul>                        | <ul style="list-style-type: none"> <li>● Strom vor Wartungsarbeiten abschalten! (Netzstrom völlig öffnen; Maschine anhalten!)</li> </ul>                                                     | <ul style="list-style-type: none"> <li>● Anlage nie ohne Schutzgehäuse oder Innenschutzverkleidung in Betrieb setzen!</li> </ul>                                | German<br><b>WARNUNG</b>              |
| <ul style="list-style-type: none"> <li>● Mantenha seu rosto da fumaça.</li> <li>● Use ventilação e exaustão para remover fumo da zona respiratória.</li> </ul>                                | <ul style="list-style-type: none"> <li>● Não opere com as tampas removidas.</li> <li>● Desligue a corrente antes de fazer serviço.</li> <li>● Não toque as partes elétricas nuas.</li> </ul> | <ul style="list-style-type: none"> <li>● Mantenha-se afastado das partes moventes.</li> <li>● Não opere com os painéis abertos ou guardas removidas.</li> </ul> | Portuguese<br><b>ATENÇÃO</b>          |
| <ul style="list-style-type: none"> <li>● ヒュームから頭を離すようにして下さい。</li> <li>● 換気や排煙に十分留意して下さい。</li> </ul>                                                                                           | <ul style="list-style-type: none"> <li>● メンテナンス・サービスに取りかかる際には、まず電源スイッチを必ず切して下さい。</li> </ul>                                                                                                  | <ul style="list-style-type: none"> <li>● パネルやカバーを取り外したまま機械操作をしないで下さい。</li> </ul>                                                                                | Japanese<br><b>注意事項</b>               |
| <ul style="list-style-type: none"> <li>● 頭部遠離煙霧。</li> <li>● 在呼吸區使用通風或排風器除煙。</li> </ul>                                                                                                        | <ul style="list-style-type: none"> <li>● 維修前切斷電源。</li> </ul>                                                                                                                                 | <ul style="list-style-type: none"> <li>● 儀表板打開或沒有安全罩時不準作業。</li> </ul>                                                                                           | Chinese<br><b>警告</b>                  |
| <ul style="list-style-type: none"> <li>● 얼굴로부터 용접가스를 멀리하십시오.</li> <li>● 호흡지역으로부터 용접가스를 제거하기 위해 가스제거기나 통풍기를 사용하십시오.</li> </ul>                                                                 | <ul style="list-style-type: none"> <li>● 보수전에 전원을 차단하십시오.</li> </ul>                                                                                                                         | <ul style="list-style-type: none"> <li>● 판넬이 열린 상태로 작동치 마십시오.</li> </ul>                                                                                        | Korean<br><b>위험</b>                   |
| <ul style="list-style-type: none"> <li>● ابعد رأسك بعيداً عن الدخان.</li> <li>● استعمل التهوية أو جهاز ضغط الدخان للخارج لكي تبعد الدخان عن المنطقة التي تتنفس فيها.</li> </ul>               | <ul style="list-style-type: none"> <li>● أقطع التيار الكهربائي قبل القيام بأية صيانة.</li> </ul>                                                                                             | <ul style="list-style-type: none"> <li>● لا تشغيل هذا الجهاز اذا كانت الاغطية الحديدية الواقية ليست عليه.</li> </ul>                                            | Arabic<br><b>تحذير</b>                |

**LEIA E COMPREENDA AS INSTRUÇÕES DO FABRICANTE PARA ESTE EQUIPAMENTO E AS PARTES DE USO, E SIGA AS PRÁTICAS DE SEGURANÇA DO EMPREGADOR.**

使う機械や溶材のメーカーの指示書をよく読み、まず理解して下さい。そして貴社の安全規定に従って下さい。

請詳細閱讀並理解製造廠提供的說明以及應該使用的銀焊材料，並請遵守貴方的有閣勞動保護規定。

이 제품에 동봉된 작업지침서를 숙지하시고 귀사의 작업자 안전수칙을 준수하시기 바랍니다.

اقرأ بتمعن وافهم تعليمات المصنع المنتج لهذه المعدات والمواد قبل استعمالها واتبع تعليمات الوقاية لصاحب العمل.



• World's Leader in Welding and Cutting Products •

• Sales and Service through Subsidiaries and Distributors Worldwide •

Cleveland, Ohio 44117-1199 U.S.A. TEL: 216.481.8100 FAX: 216.486.1751 WEB SITE: [www.lincolnelectric.com](http://www.lincolnelectric.com)