

LT-7 TRACTOR TROUBLESHOOTING

JUNE 1995

Safety Depends on You

Lincoln arc welding and cutting equipment is designed and built with safety in mind. However, your overall safety can be increased by proper installation ... and thoughtful operation on your part. **DO NOT INSTALL, OPERATE OR REPAIR THIS EQUIPMENT WITHOUT READING THIS MANUAL AND THE SAFETY PRECAUTIONS CONTAINED THROUGHOUT.** And, most importantly, think before you act and be careful.

TROUBLE SHOOTING GUIDE



World's Leader in Welding and Cutting Products

Premier Manufacturer of Industrial Motors

Sales and Service through Subsidiaries and Distributors Worldwide
22801 St. Clair Ave. Cleveland, Ohio 44117-1199 U.S.A. Tel. (216) 481-8100

⚠ WARNING

⚠ CALIFORNIA PROPOSITION 65 WARNINGS ⚠

Diesel engine exhaust and some of its constituents are known to the State of California to cause cancer, birth defects, and other reproductive harm.

The Above For Diesel Engines

The engine exhaust from this product contains chemicals known to the State of California to cause cancer, birth defects, or other reproductive harm.

The Above For Gasoline Engines

ARC WELDING CAN BE HAZARDOUS. PROTECT YOURSELF AND OTHERS FROM POSSIBLE SERIOUS INJURY OR DEATH. KEEP CHILDREN AWAY. PACEMAKER WEARERS SHOULD CONSULT WITH THEIR DOCTOR BEFORE OPERATING.

Read and understand the following safety highlights. For additional safety information, it is strongly recommended that you purchase a copy of "Safety in Welding & Cutting - ANSI Standard Z49.1" from the American Welding Society, P.O. Box 351040, Miami, Florida 33135 or CSA Standard W117.2-1974. A Free copy of "Arc Welding Safety" booklet E205 is available from the Lincoln Electric Company, 22801 St. Clair Avenue, Cleveland, Ohio 44117-1199.

BE SURE THAT ALL INSTALLATION, OPERATION, MAINTENANCE AND REPAIR PROCEDURES ARE PERFORMED ONLY BY QUALIFIED INDIVIDUALS.



FOR ENGINE powered equipment.

1.a. Turn the engine off before troubleshooting and maintenance work unless the maintenance work requires it to be running.



1.b. Operate engines in open, well-ventilated areas or vent the engine exhaust fumes outdoors.



1.c. Do not add the fuel near an open flame welding arc or when the engine is running. Stop the engine and allow it to cool before refueling to prevent spilled fuel from vaporizing on contact with hot engine parts and igniting. Do not spill fuel when filling tank. If fuel is spilled, wipe it up and do not start engine until fumes have been eliminated.



1.d. Keep all equipment safety guards, covers and devices in position and in good repair. Keep hands, hair, clothing and tools away from V-belts, gears, fans and all other moving parts when starting, operating or repairing equipment.

1.e. In some cases it may be necessary to remove safety guards to perform required maintenance. Remove guards only when necessary and replace them when the maintenance requiring their removal is complete. Always use the greatest care when working near moving parts.

1.f. Do not put your hands near the engine fan. Do not attempt to override the governor or idler by pushing on the throttle control rods while the engine is running.

1.g. To prevent accidentally starting gasoline engines while turning the engine or welding generator during maintenance work, disconnect the spark plug wires, distributor cap or magneto wire as appropriate.

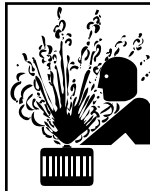

1.h. To avoid scalding, do not remove the radiator pressure cap when the engine is hot.



ELECTRIC AND MAGNETIC FIELDS may be dangerous

2.a. Electric current flowing through any conductor causes localized Electric and Magnetic Fields (EMF). Welding current creates EMF fields around welding cables and welding machines

2.b. EMF fields may interfere with some pacemakers, and welders having a pacemaker should consult their physician before welding.

2.c. Exposure to EMF fields in welding may have other health effects which are now not known.

2.d. All welders should use the following procedures in order to minimize exposure to EMF fields from the welding circuit:

2.d.1. Route the electrode and work cables together - Secure them with tape when possible.

2.d.2. Never coil the electrode lead around your body.

2.d.3. Do not place your body between the electrode and work cables. If the electrode cable is on your right side, the work cable should also be on your right side.

2.d.4. Connect the work cable to the workpiece as close as possible to the area being welded.

2.d.5. Do not work next to welding power source.

Mar '95



ELECTRIC SHOCK can kill.

3.a. The electrode and work (or ground) circuits are electrically "hot" when the welder is on. Do not touch these "hot" parts with your bare skin or wet clothing. Wear dry, hole-free gloves to insulate hands.

3.b. Insulate yourself from work and ground using dry insulation. Make certain the insulation is large enough to cover your full area of physical contact with work and ground.

In addition to the normal safety precautions, if welding must be performed under electrically hazardous conditions (in damp locations or while wearing wet clothing; on metal structures such as floors, gratings or scaffolds; when in cramped positions such as sitting, kneeling or lying, if there is a high risk of unavoidable or accidental contact with the workpiece or ground) use the following equipment:

- Semiautomatic DC Constant Voltage (Wire) Welder.
- DC Manual (Stick) Welder.
- AC Welder with Reduced Voltage Control.

3.c. In semiautomatic or automatic wire welding, the electrode, electrode reel, welding head, nozzle or semiautomatic welding gun are also electrically "hot".

3.d. Always be sure the work cable makes a good electrical connection with the metal being welded. The connection should be as close as possible to the area being welded.

3.e. Ground the work or metal to be welded to a good electrical (earth) ground.

3.f. Maintain the electrode holder, work clamp, welding cable and welding machine in good, safe operating condition. Replace damaged insulation.

3.g. Never dip the electrode in water for cooling.

3.h. Never simultaneously touch electrically "hot" parts of electrode holders connected to two welders because voltage between the two can be the total of the open circuit voltage of both welders.

3.i. When working above floor level, use a safety belt to protect yourself from a fall should you get a shock.

3.j. Also see Items 6.c. and 8.



ARC RAYS can burn.

4.a. Use a shield with the proper filter and cover plates to protect your eyes from sparks and the rays of the arc when welding or observing open arc welding. Headshield and filter lens should conform to ANSI Z87.1 standards.

4.b. Use suitable clothing made from durable flame-resistant material to protect your skin and that of your helpers from the arc rays.

4.c. Protect other nearby personnel with suitable, non-flammable screening and/or warn them not to watch the arc nor expose themselves to the arc rays or to hot spatter or metal.



FUMES AND GASES can be dangerous.

5.a. Welding may produce fumes and gases hazardous to health. Avoid breathing these fumes and gases. When welding, keep your head out of the fume. Use enough ventilation and/or exhaust at the arc to keep

fumes and gases away from the breathing zone. **When welding with electrodes which require special ventilation such as stainless or hard facing (see instructions on container or MSDS) or on lead or cadmium plated steel and other metals or coatings which produce highly toxic fumes, keep exposure as low as possible and below Threshold Limit Values (TLV) using local exhaust or mechanical ventilation. In confined spaces or in some circumstances, outdoors, a respirator may be required. Additional precautions are also required when welding on galvanized steel.**

5.b. Do not weld in locations near chlorinated hydrocarbon vapors coming from degreasing, cleaning or spraying operations. The heat and rays of the arc can react with solvent vapors to form phosgene, a highly toxic gas, and other irritating products.

5.c. Shielding gases used for arc welding can displace air and cause injury or death. Always use enough ventilation, especially in confined areas, to insure breathing air is safe.

5.d. Read and understand the manufacturer's instructions for this equipment and the consumables to be used, including the material safety data sheet (MSDS) and follow your employer's safety practices. MSDS forms are available from your welding distributor or from the manufacturer.

5.e. Also see item 1.b.

Mar '95



WELDING SPARKS can cause fire or explosion.

6.a. Remove fire hazards from the welding area. If this is not possible, cover them to prevent the welding sparks from starting a fire.

Remember that welding sparks and hot materials from welding can easily go through small cracks and openings to adjacent areas. Avoid welding near hydraulic lines. Have a fire extinguisher readily available.

- 6.b. Where compressed gases are to be used at the job site, special precautions should be used to prevent hazardous situations. Refer to "Safety in Welding and Cutting" (ANSI Standard Z49.1) and the operating information for the equipment being used.
- 6.c. When not welding, make certain no part of the electrode circuit is touching the work or ground. Accidental contact can cause overheating and create a fire hazard.
- 6.d. Do not heat, cut or weld tanks, drums or containers until the proper steps have been taken to insure that such procedures will not cause flammable or toxic vapors from substances inside. They can cause an explosion even though they have been "cleaned". For information, purchase "Recommended Safe Practices for the Preparation for Welding and Cutting of Containers and Piping That Have Held Hazardous Substances", AWS F4.1 from the American Welding Society (see address above).
- 6.e. Vent hollow castings or containers before heating, cutting or welding. They may explode.
- 6.f. Sparks and spatter are thrown from the welding arc. Wear oil free protective garments such as leather gloves, heavy shirt, cuffless trousers, high shoes and a cap over your hair. Wear ear plugs when welding out of position or in confined places. Always wear safety glasses with side shields when in a welding area.
- 6.g. Connect the work cable to the work as close to the welding area as practical. Work cables connected to the building framework or other locations away from the welding area increase the possibility of the welding current passing through lifting chains, crane cables or other alternate circuits. This can create fire hazards or overheat lifting chains or cables until they fail.
- 6.h. Also see item 1.c.

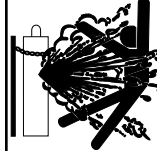

CYLINDER may explode if damaged.

7.a. Use only compressed gas cylinders containing the correct shielding gas for the process used and properly operating regulators designed for the gas and pressure used. All hoses, fittings, etc. should be suitable for the application and maintained in good condition.

- 7.b. Always keep cylinders in an upright position securely chained to an undercarriage or fixed support.
- 7.c. Cylinders should be located:
 - Away from areas where they may be struck or subjected to physical damage.
 - A safe distance from arc welding or cutting operations and any other source of heat, sparks, or flame.
- 7.d. Never allow the electrode, electrode holder or any other electrically "hot" parts to touch a cylinder.
- 7.e. Keep your head and face away from the cylinder valve outlet when opening the cylinder valve.
- 7.f. Valve protection caps should always be in place and hand tight except when the cylinder is in use or connected for use.
- 7.g. Read and follow the instructions on compressed gas cylinders, associated equipment, and CGA publication P-1, "Precautions for Safe Handling of Compressed Gases in Cylinders," available from the Compressed Gas Association 1235 Jefferson Davis Highway, Arlington, VA 22202.



FOR ELECTRICALLY powered equipment.

- 8.a. Turn off input power using the disconnect switch at the fuse box before working on the equipment.
- 8.b. Install equipment in accordance with the U.S. National Electrical Code, all local codes and the manufacturer's recommendations.
- 8.c. Ground the equipment in accordance with the U.S. National Electrical Code and the manufacturer's recommendations.

Mar '95

Theory of Operation	Section A
General Description	A-1
Input Power Circuits	A-1
Control Logic and Travel Boards	A-2
Variable Voltage Board	A-3
<hr/>	
Troubleshooting and Repair	Section B
How to Use Troubleshooting Guide	B-2
PC Board Troubleshooting Procedures	B-3
Troubleshooting Guide	B-4
P.C. Board Status Lights	B-21
Wire Drive Motor Test	B-24
Travel Motor Test	B-26
Wire Drive Motor Removal and Replacement	B-30
<hr/>	
Diagrams	Section C
M15342 Connection Schematic	C-1
L7460 Control Box Wiring Diagram	C-2

⚠ WARNING



ELECTRIC SHOCK can kill.

- Never work on the inside of the machine without removing the input power. You can receive a life threatening electrical shock if you fail to do this. Only qualified technicians should perform installation, maintenance, and troubleshooting work on the machine.
-

GENERAL DESCRIPTION

The LT-7 tractor is a compact, lightweight, DC, single arc tractor. It is capable of operating with 3/32" through 3/16" electrode with a current carrying capacity of 1000 amps. The LT-7 has a travel range from 6 to 70 inches per minute.

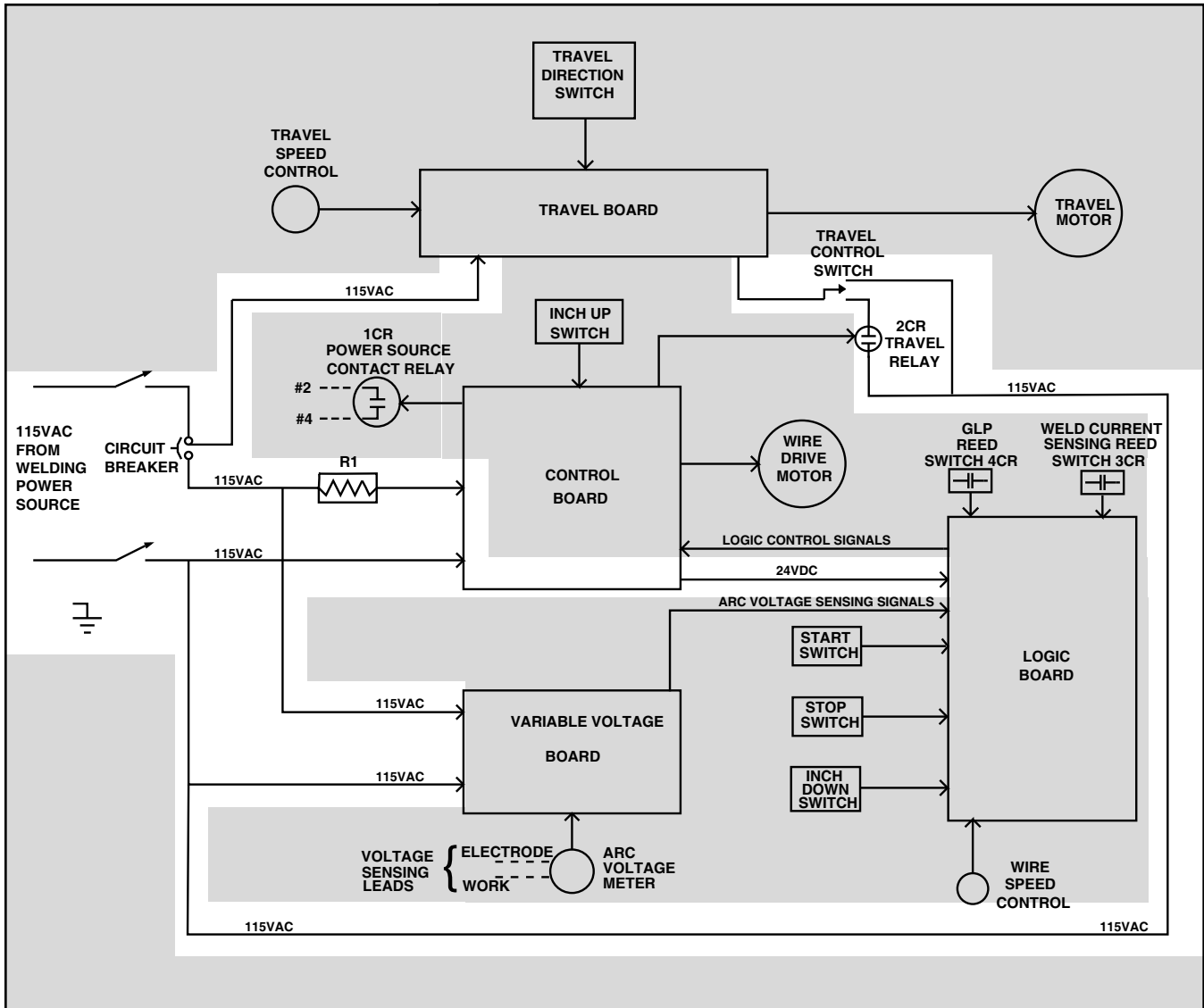

FIGURE E.1 - 115VAC INPUT POWER CIRCUITS

INPUT POWER CIRCUITS

The LT7 is powered by 115VAC which is usually supplied from the welding power source. The 115VAC is applied to the travel board. This voltage is also coupled to the control box circuitry through the on/off power switch and a 3 amp circuit breaker. The input power is then applied to the the variable voltage board and, through resistor R1, to the control board. The 115VAC is rectified and regulated by the control board which supplies 24VDC to the logic board.

NOTE: Unshaded areas of the Block Logic Diagram are the subject of discussion

LT-7 TRACTOR



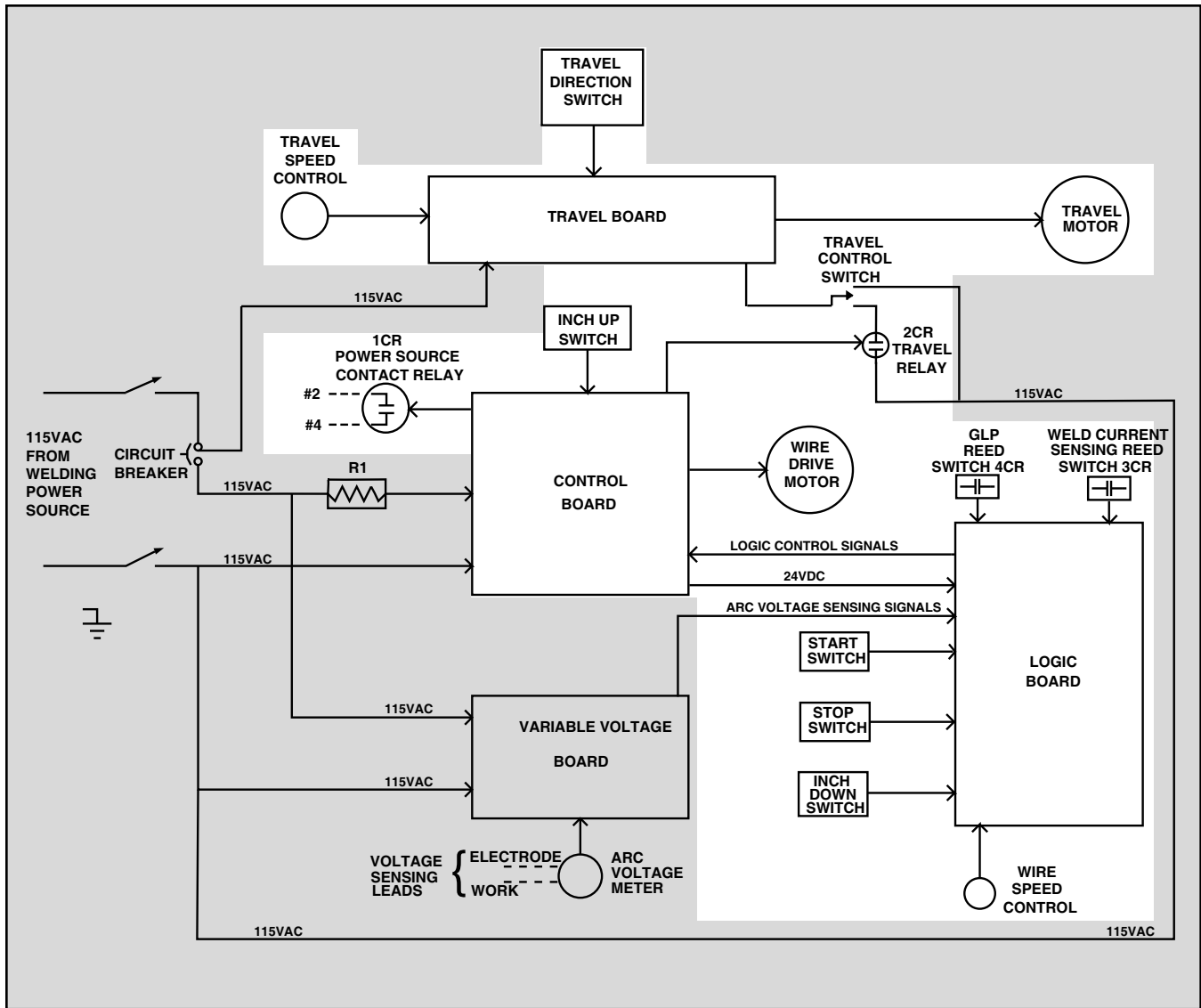

FIGURE E.2 - CONTROL LOGIC AND TRAVEL BOARDS

CONTROL, LOGIC AND TRAVEL BOARDS

Upon receiving commands from the user operated switches or potentiometers the logic board sends the appropriate signal to the control board which then drives the wire feed motor to the correct speed and direction. When the start signal is received by the control board the power source contact relay(1CR) is energized as well as the travel relay(2CR) and the wire drive motor. When weld current closes reed switch 3CR the logic board directs the control board to change the wire feed speed from the preset inch speed to the welding feed speed set by the wire speed control potentiometer. Reed switch 4CR protects the internal grounding wire circuitry. In the event that abnormally high current

was to flow in the grounding lead system the 4CR reed switch would close, signaling the logic board to stop the welding procedure. The inch up switch, which is coupled directly to the control board, dictates that the wire drive motor reverse direction and back the electrode wire away from the work piece.

Travel speed, direction and mode (either manual or auto) are determined by the settings of the three controls connected to the travel board. The travel board then applies the correct voltage and polarity to the travel motor to satisfy the control settings.

NOTE: Unshaded areas of the Block Logic Diagram are the subject of discussion

LT-7 TRACTOR



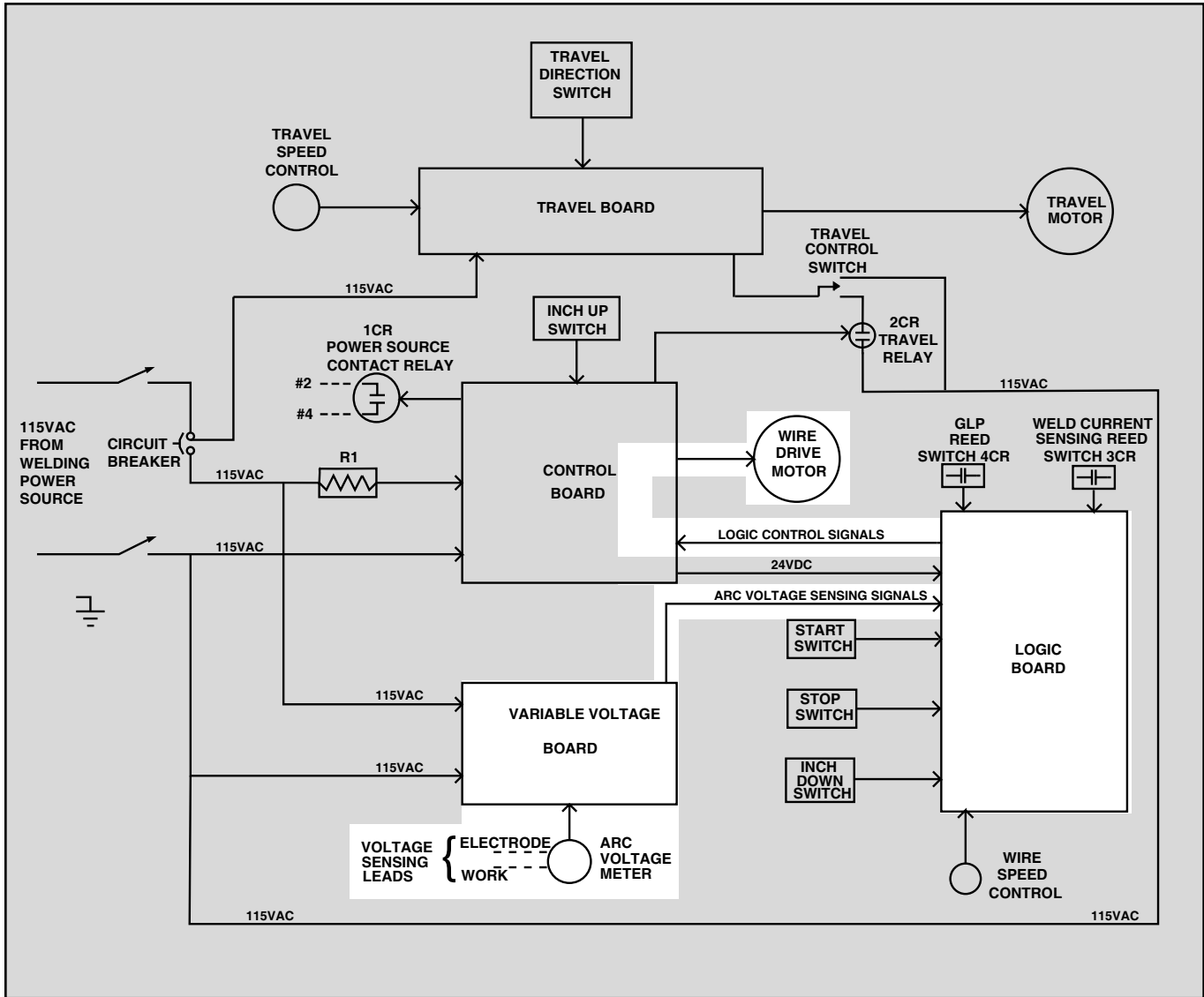

FIGURE E.3 - VARIABLE VOLTAGE BOARD

VARIABLE VOLTAGE BOARD

Arc voltage is monitored by the voltmeter and variable voltage board. When the LT7 tractor is being operated in the constant current mode the variable voltage board is essential in the control of the wire feed speed. As the arc length changes the arc voltage will also change. The variable voltage board recognizes this change and signals the logic board to either increase or decrease the wire feed speed. This function is necessary to maintain a constant electrode arc length and a stable and high quality weld.

The variable voltage board also generates a low voltage which is applied to the electrode during the inch

down mode. When the electrode makes contact with the work piece this low voltage is “loaded down” thus signaling the control circuitry to stop the wire feed motor. This feature allows the operator to utilize “work touch sensing”.

NOTE: Unshaded areas of the Block Logic Diagram are the subject of discussion

LT-7 TRACTOR



LT-7 TRACTOR



How To Use Troubleshooting Guide

WARNING

Service and Repair should only be performed by Lincoln Electric Factory Trained Personnel. Unauthorized repairs performed on this equipment may result in danger to the technician and machine operator and will invalidate your factory warranty. For your safety and to avoid Electrical Shock, please observe all safety notes and precautions detailed throughout this manual.

This Troubleshooting Guide is provided to help you locate and repair possible machine malfunctions. Simply follow the three step procedure below.

Step 1. LOCATE PROBLEM (SYMPTOM). Look under the column labeled “PROBLEM (SYMPTOMS)”. This column describes possible symptoms that the machinery may exhibit. Find the listing that best describes the symptom that the machine is exhibiting. Symptoms are grouped according to: function problems and travel problems.

Step 2. PERFORM EXTERNAL TESTS. The second column labeled “FIELD COURSE OF ACTION” lists the basic possibilities that may contribute to the machine symptom. Perform these tests/checks in the order listed.

Step 3. PERFORM COMPONENT TESTS. The last column labeled “RECOMMENDED SHOP COURSE OF ACTION” lists the most likely components that may have failed in your machine. It also specifies the appropriate test procedure to verify that the subject component is either bad or good. If there are a number of possible components, check the components in the order listed to eliminate one possibility at a time until you locate the cause of your problem.

All the necessary test specifications and repair procedures are described in detail following the troubleshooting guide. All electrical test points, terminal strips, junctions, etc., can be found on the electrical wiring diagrams and schematics in the Electrical Diagram Section.

CAUTION

If for any reason you do not understand the test procedures or are unable to perform the tests/repairs safely, contact the Lincoln Electric Service Department for technical troubleshooting assistance before you proceed. Call 216-383-2531 or 1-800-833-9353.

PC BOARD TROUBLESHOOTING PROCEDURES

⚠ WARNING**ELECTRIC SHOCK
can kill.**

*Have an electrician install and service this equipment. Turn the input power OFF at the fuse box before working on equipment. Do not touch electrically hot parts.

⚠ CAUTION

Sometimes machine failures appear to be due to PC board failures. These problems can sometimes be traced to poor electrical connections. To avoid problems when troubleshooting and replacing PC boards, please use the following procedure:

1. Determine to the best of your technical ability that the PC board is the most likely component causing the failure symptom.
2. Check for loose connections at the PC board to assure that the PC board is properly connected.
3. If the problem persists, replace the suspect PC board using standard practices to avoid static electrical damage and electrical shock. Read the warning inside the static resistant bag and perform the following procedures:

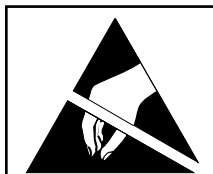

ATTENTION
Static-Sensitive
Devices
Handle only at
Static-Safe
Workstations

Reusable
Container
Do Not Destroy

**PC board can be
damaged by static
electricity.**

- Remove your body's static charge before opening the static-shielding bag. Wear an anti-static wrist strap. For safety, use a 1 Meg ohm resistive cord connected to a grounded part of the equipment frame.

- If you don't have a wrist strap, touch an unpainted, grounded, part of the equipment frame. Keep touching the frame to prevent static build-up. Be sure not to touch any electrically live parts at the same time.

- Tools which come in contact with the PC board must be either conductive, anti-static or static-dissipative.

- Remove the PC board from the static-shielding bag and place it directly into the equipment. Don't set the PC board on or near paper, plastic or cloth which could have a static charge. If the PC board can't be installed immediately, put it back in the static-shielding bag.

- If the PC board uses protective shorting jumpers, don't remove them until installation is complete.

- If you return a PC board to The Lincoln Electric Company for credit, it must be in the static-shielding bag. This will prevent further damage and allow proper failure analysis.

4. Test the machine to determine if the failure symptom has been corrected by the replacement PC board.

NOTE: It is desirable to have a spare (known good) PC board available for PC board troubleshooting.

NOTE: Allow the machine to heat up so that all electrical components can reach their operating temperature.

5. Remove the replacement PC board and substitute it with the original PC board to recreate the original problem.
 - a. If the original problem does not reappear by substituting the original board, then the PC board was not the problem. Continue to look for bad connections in the control wiring harness, junction blocks, and terminal strips.
 - b. If the original problem is recreated by the substitution of the original board, then the PC board was the problem. Reinstall the replacement PC board and test the machine.

6. Always indicate that this procedure was followed when warranty reports are to be submitted.

NOTE: Following this procedure and writing on the warranty report, "INSTALLED AND SWITCHED PC BOARDS TO VERIFY PROBLEM," will help avoid denial of legitimate PC board warranty claims.

LT-7 TRACTOR



Troubleshooting Guide — See Wiring Diagrams for location of specified components. See Wiring Diagrams for troubleshooting of specific circuits.

Observe Safety Guidelines detailed in the beginning of this manual.

PROBLEMS (SYMPTOMS)	FIELD COURSE OF ACTION	RECOMMENDED SHOP COURSE OF ACTION
FUNCTIONAL PROBLEMS		
<p>Wire feeds whenever "Power Switch" (S1) is turned "ON".</p>	<ol style="list-style-type: none"> 1. Check the "Start Switch"(S5). Make certain it is not stuck closed. 2. Check the "Inch Down Switch" (S4). Make certain it is not stuck closed. 3. Check the "Inch Up Switch" (S3). Make certain it is not stuck closed. 	<ol style="list-style-type: none"> 1. If light 1B on the control board is NOT on, then the control board may be faulty. Replace. 2. If lights 1B and 1A are both "ON" then remove lead #593 from the Inch Up switch(S3). If the problem is resolved the lead or the switch is faulty. If light 1A stays on when lead #593 is removed from the Inch Up switch the control board may be faulty. Replace. 3. If lights 1B, on the control board, and 2B on the logic board, are both "ON" then remove lead #581 from the Start switch(S5). If the problem is resolved the lead or the switch is faulty. If light 2B stays on when lead #581 is removed from the Start Switch the logic board may be faulty. Replace. 4. If lights 1B, on the control board, and 2J on the logic board are both "ON" then remove lead #592 from the Inch Down switch (S4). If the problem is resolved the lead or the switch is faulty. If light 2J stays on when lead #592 is removed from the Inch Down switch the logic board may be faulty. Replace.

⚠ CAUTION

If for any reason you do not understand the test procedures or are unable to perform the tests/repairs safely, contact the Lincoln Electric Service Department for electrical technical troubleshooting assistance before you proceed. Call 216-383-2531 or 1-800-833-9353

Troubleshooting Guide — See Wiring Diagrams for location of specified components. See Wiring Diagrams for troubleshooting of specific circuits.

Observe Safety Guidelines detailed in the beginning of this manual.

PROBLEMS (SYMPTOMS)	FIELD COURSE OF ACTION	RECOMMENDED SHOP COURSE OF ACTION
FUNCTIONAL PROBLEMS		
<p>Wire does not feed. No inch up or down. Wire does NOT feed when start switch is activated.</p>	<ol style="list-style-type: none"> 1. Make sure the Power Switch (S1) is on and functioning properly. 2. Check the circuit breaker located on the front cover. If tripped - reset. If circuit breaker repeatedly trips consult appropriate ("PROBLEMS (SYMPTOMS)"). 3. Open the front cover and inner panel to check if any of the LEDs on the printed circuit boards are lit. If none of the LEDs are lit, this is an indication that the LT7 is NOT receiving any power. Check the 2/10 amp fuse on the control board. Also make sure that 115VAC is being received on leads #531 and #532. See wiring diagram. 	<ol style="list-style-type: none"> 1. Check lights 1C and 1D on the control board. If both lights are lit at the same time replace the control board. 2. Press the inch up switch. Lights 1D and 1E, on the control board should be lit. If they are NOT lit the control board may be faulty. 3. If light 1D and 1E are lit and the wire drive motor does not turn check the continuity of leads #539, #541, #626 and #627 from the control board to the wire drive motor. 4. Perform the Wire Drive Motor Test.

⚠ CAUTION

If for any reason you do not understand the test procedures or are unable to perform the tests/repairs safely, contact the Lincoln Electric Service Department for electrical technical troubleshooting assistance before you proceed. Call 216-383-2531 or 1-800-833-9353

Troubleshooting Guide — See Wiring Diagrams for location of specified components. See Wiring Diagrams for troubleshooting of specific circuits.

Observe Safety Guidelines detailed in the beginning of this manual.

PROBLEMS (SYMPTOMS)	FIELD COURSE OF ACTION	RECOMMENDED SHOP COURSE OF ACTION
FUNCTIONAL PROBLEMS		
<p>The wire will not feed and the circuit breaker trips when the inch or start switches are pressed.</p>	<ol style="list-style-type: none"> 1. Reset the circuit breaker and observe lights 1C and 1D on the control board with the unit at idle. (Not attempting to feed wire). Light 1C should be OFF and light 1D should be ON. If both lights are OFF remove power and check F101 field fuse. (1/2amp). 2. If both lights are ON the control board may be faulty. 3. The following conditions may cause the F101 fuse to fail. <ul style="list-style-type: none"> •Faulty wire drive motor •Incorrect welding procedure. •A low impedance across the arc voltage sensing leads (#21 and #67). •A defective control board. 	<ol style="list-style-type: none"> 1. If when at idle light 1D is ON and light 1C is OFF then perform the Wire Drive Motor Test.

⚠ CAUTION

If for any reason you do not understand the test procedures or are unable to perform the tests/repairs safely, contact the Lincoln Electric Service Department for electrical technical troubleshooting assistance before you proceed. Call 216-383-2531 or 1-800-833-9353

Troubleshooting Guide — See Wiring Diagrams for location of specified components. See Wiring Diagrams for troubleshooting of specific circuits.

Observe Safety Guidelines detailed in the beginning of this manual.

PROBLEMS (SYMPTOMS)	FIELD COURSE OF ACTION	RECOMMENDED SHOP COURSE OF ACTION
FUNCTIONAL PROBLEMS		
<p>The wire will not feed when the start switch is pressed. There is not a voltage indicated on the LT7 voltmeter. The wire does inch up and down properly.</p>	<ol style="list-style-type: none"> 1. If light 2M on the logic board is lit the ground lead protector has tripped. Make sure the LT7 head or electrode is NOT contacting the LT7 frame or control box. <p>Note that conductive dirt or shavings can cause the ground lead protector to trip. Remove power to unit and clear fault.</p> <ol style="list-style-type: none"> 2. While pressing the start switch observe light 2B. It should be lit. If not the start switch (S5) or associated wires may be faulty. See wiring diagram. 	<ol style="list-style-type: none"> 1. If light 2B is on when the start switch is pressed and light 2M does NOT light then the logic board may be faulty.

⚠ CAUTION

If for any reason you do not understand the test procedures or are unable to perform the tests/repairs safely, contact the Lincoln Electric Service Department for electrical technical troubleshooting assistance before you proceed. Call 216-383-2531 or 1-800-833-9353

Troubleshooting Guide — See Wiring Diagrams for location of specified components. See Wiring Diagrams for troubleshooting of specific circuits.

Observe Safety Guidelines detailed in the beginning of this manual.

PROBLEMS (SYMPTOMS)	FIELD COURSE OF ACTION	RECOMMENDED SHOP COURSE OF ACTION
FUNCTIONAL PROBLEMS		
<p>The wire will NOT inch down but does inch up properly. When the start switch is pressed the wire feeds down properly.</p>	<ol style="list-style-type: none"> 1. While pressing the inch down switch observe light 2J. It should be lit. If not the inch down switch (S4) or associated wires may be faulty. See wiring diagram. 2. If the LT7 is in the constant voltage (CV) mode and light 2J does light then the logic board may be faulty. 	<ol style="list-style-type: none"> 1. If the LT7 is in the variable voltage (VV) mode, and a variable voltage board is installed, disconnect lead #21 from the terminal strip. Turn on input power and while pressing the inch down switch observe light 3A. If light 3A does NOT light the variable voltage board may be faulty. Replace board and reconnect lead #21. <p>If light 3A does light, with lead #21 disconnected, the resistance across leads #21 and #67 is too low. The resistance must be above 500 ohms. The low resistance could be caused by the following:</p> <ul style="list-style-type: none"> • A lead or object external to the power source or LT7 causing a low resistance between leads #21 and #67. • A non-Lincoln power source not designed with the required impedance. • A defective power source.

⚠ CAUTION

If for any reason you do not understand the test procedures or are unable to perform the tests/repairs safely, contact the Lincoln Electric Service Department for electrical technical troubleshooting assistance before you proceed. Call 216-383-2531 or 1-800-833-9353



Troubleshooting Guide — See Wiring Diagrams for location of specified components. See Wiring Diagrams for troubleshooting of specific circuits.

Observe Safety Guidelines detailed in the beginning of this manual.

PROBLEMS (SYMPTOMS)	FIELD COURSE OF ACTION	RECOMMENDED SHOP COURSE OF ACTION
FUNCTIONAL PROBLEMS		
<p>The wire will NOT inch down but inches up properly. When the start switch is pressed the wire does not feed.</p>	<p>1. Press the inch down switch and observe light 1B on the control board. If light 1B is lit and the motor does not activate the control board may be faulty.</p>	<p>1. If light 1B does NOT light, when the inch down switch is pressed, measure the DC voltage from lead #586 to lead #539 while pressing the inch down switch. Normal voltage is 12 to 15VDC.</p> <ul style="list-style-type: none"> •If normal voltage is indicated the control board may be faulty. •If normal voltage is not present the logic board may be faulty.

⚠ CAUTION

If for any reason you do not understand the test procedures or are unable to perform the tests/repairs safely, contact the Lincoln Electric Service Department for electrical technical troubleshooting assistance before you proceed. Call 216-383-2531 or 1-800-833-9353

Troubleshooting Guide – See Wiring Diagrams for location of specified components. See Wiring Diagrams for troubleshooting of specific circuits.

Observe Safety Guidelines detailed in the beginning of this manual.

PROBLEMS (SYMPTOMS)	FIELD COURSE OF ACTION	RECOMMENDED SHOP COURSE OF ACTION
FUNCTIONAL PROBLEMS		
<p>The wire will not inch down. The wire inches up properly. When the start switch is pressed the wire feeds up instead of down.</p>	<ol style="list-style-type: none"> 1. Check the connections between the power source and LT7 for loose or incorrect connections. 2. Check the leads connected to the variable voltage board for loose or faulty connections. 3. While pressing the inch down switch observe light 3A on the variable voltage board. <ul style="list-style-type: none"> • If light 3A is NOT lit check leads #21 and #67 for continuity to the voltage board. 4. If while pressing the inch down switch light 3A does light also check light 2E on the logic board. <ul style="list-style-type: none"> • If light 3A and 2E are both lit the control board may be faulty. • If light 3A is lit but light 2E is NOT lit the logic board may be faulty. 	<ol style="list-style-type: none"> 1. Check lead #21 for continuity (zero ohms) to “work”. 2. Check lead #67 for continuity (zero ohms) to electrode.

⚠ CAUTION

If for any reason you do not understand the test procedures or are unable to perform the tests/repairs safely, contact the Lincoln Electric Service Department for electrical technical troubleshooting assistance before you proceed. Call 216-383-2531 or 1-800-833-9353



Troubleshooting Guide — See Wiring Diagrams for location of specified components. See Wiring Diagrams for troubleshooting of specific circuits.

Observe Safety Guidelines detailed in the beginning of this manual.

PROBLEMS (SYMPTOMS)	FIELD COURSE OF ACTION	RECOMMENDED SHOP COURSE OF ACTION
FUNCTIONAL PROBLEMS		
<p>When attempting to “cold start” the wire does not stop feeding when it touches the work piece.</p>	<ol style="list-style-type: none"> 1. Make certain a variable voltage board is installed and connected correctly. 2. The jumper on the variable voltage board must be connected to the “H” pin. 3. The logic board may be faulty. 4. The variable voltage board may be faulty. 	<ol style="list-style-type: none"> 1. Check lead #21 for continuity (zero ohms) to “work”. 2. Check lead #67 for continuity (zero ohms) to electrode.
<p>The wire will not inch up. The wire inches down properly.</p>	<ol style="list-style-type: none"> 1. With LT7 at idle (not feeding wire) observe light 1D on the control board. The light should be lit. If light is NOT lit the control board may be faulty. 2. While pressing the inch up switch observe light 1A on the control board. If light 1A does NOT light check the inch up switch and associated leads. (#593 and #539) See wiring diagram. 3. If light 1A is lit the control board may be faulty. 	<ol style="list-style-type: none"> 1. Perform the Wire Drive Motor Test.

⚠ CAUTION

If for any reason you do not understand the test procedures or are unable to perform the tests/repairs safely, contact the Lincoln Electric Service Department for electrical technical troubleshooting assistance before you proceed. Call 216-383-2531 or 1-800-833-9353

Troubleshooting Guide — See Wiring Diagrams for location of specified components. See Wiring Diagrams for troubleshooting of specific circuits.

Observe Safety Guidelines detailed in the beginning of this manual.

PROBLEMS (SYMPTOMS)	FIELD COURSE OF ACTION	RECOMMENDED SHOP COURSE OF ACTION
FUNCTIONAL PROBLEMS		
<p>The wire feeds up with either inch switch.</p>	<ol style="list-style-type: none"> 1. While pressing the inch down switch observe light 2E on the logic board. If light 2E does NOT light the logic board may be faulty. 2. If light 2E does light the control board may be faulty. 	<ol style="list-style-type: none"> 1. Check the wiring to the inch down switch. See wiring diagram. 2. Check the wiring between the logic board and the control board. See wiring diagram.
<p>The wire feeds down with either inch switch.</p>	<ol style="list-style-type: none"> 1. With the LT7 at idle (not feeding wire) observe light 2E on the logic board. It should be off. If light 2E is on the logic board may be faulty. 2. If light 2E is off the control board may be faulty. 	<ol style="list-style-type: none"> 1. Check the wiring to the inch up switch. See wiring diagram. 2. Check the wiring between the logic board and the control board. See wiring diagram.

⚠ CAUTION

If for any reason you do not understand the test procedures or are unable to perform the tests/repairs safely, contact the Lincoln Electric Service Department for electrical technical troubleshooting assistance before you proceed. Call 216-383-2531 or 1-800-833-9353

Troubleshooting Guide — See Wiring Diagrams for location of specified components. See Wiring Diagrams for troubleshooting of specific circuits.

Observe Safety Guidelines detailed in the beginning of this manual.

PROBLEMS (SYMPTOMS)	FIELD COURSE OF ACTION	RECOMMENDED SHOP COURSE OF ACTION
FUNCTIONAL PROBLEMS		
<p>The wire feeds at full speed during the inch mode (only).</p>	<p>1. The logic board may be faulty.</p>	<p>1. Check the wiring between the logic board and the control board. See wiring diagram.</p> <p>2. Perform the <i>Wire Drive Motor Test</i>.</p>
<p>The wire feeds at full speed during the weld mode (only).</p>	<p>1. Remove electrode from drive rolls and place a jumper wire from lead #528 to lead #539 on the reed switch(CR3) in the shunt box. Press the start switch and observe lights 2L and 2D on the logic board. Both lights should be on. If light 2D is lit and light 2L is NOT lit the logic board may be faulty.</p> <p>2. If light 2D does not light check continuity (zero ohms) of leads #528 and #539 from the reed switch (CR3) to the logic board. See wiring diagram.</p>	<p>1. Check leads #634, #641 and #642 between wire feed speed control (R3) and logic board.</p> <p>2. Check R3 rheostat for correct resistance (5000 ohms) and proper function.</p>

⚠ CAUTION

If for any reason you do not understand the test procedures or are unable to perform the tests/repairs safely, contact the Lincoln Electric Service Department for electrical technical troubleshooting assistance before you proceed. Call 216-383-2531 or 1-800-833-9353

Troubleshooting Guide — See Wiring Diagrams for location of specified components. See Wiring Diagrams for troubleshooting of specific circuits.

Observe Safety Guidelines detailed in the beginning of this manual.

PROBLEMS (SYMPTOMS)	FIELD COURSE OF ACTION	RECOMMENDED SHOP COURSE OF ACTION
FUNCTIONAL PROBLEMS		
<p>The wire feeds at full speed in both inch and weld modes.</p>	<ol style="list-style-type: none"> 1. With the LT7 at idle (not feeding wire) observe light 2F on the logic board. If light 2F is lit the control board may be faulty. 2. If light 2F is not lit the logic board may be faulty. 	<ol style="list-style-type: none"> 1. Perform the <i>Wire Drive Motor Test</i>.
<p>The wire has limited or erratic speed control in one or more modes.</p>	<ol style="list-style-type: none"> 1. Make sure the CV-VV switch is in the CV mode. If the problem is solved the variable voltage board may be faulty. 2. The logic board may be faulty. 3. The control board may be faulty. 	<ol style="list-style-type: none"> 1. Perform the <i>Wire Drive Motor Test</i>. 2. Check the wire feed speed control (R3) for resistance and smooth operation. Normal resistance is 5000 ohms.

⚠ CAUTION

If for any reason you do not understand the test procedures or are unable to perform the tests/repairs safely, contact the Lincoln Electric Service Department for electrical technical troubleshooting assistance before you proceed. Call 216-383-2531 or 1-800-833-9353

Troubleshooting Guide — See Wiring Diagrams for location of specified components. See Wiring Diagrams for troubleshooting of specific circuits.

Observe Safety Guidelines detailed in the beginning of this manual.

PROBLEMS (SYMPTOMS)	FIELD COURSE OF ACTION	RECOMMENDED SHOP COURSE OF ACTION
FUNCTIONAL PROBLEMS		
<p>The wire feeds up instead of down when the start switch is pressed. There is no voltage reading on LT7 voltmeter. The wire inches up and down properly.</p>	<ol style="list-style-type: none"> 1. Check for proper connection of electrode leads and control cable leads from power source to LT7. 2. On Lincoln power sources put a jumper from #2 to #4 on the terminal strip. This activates the output from the power source. Test for voltage at the output terminals of the power source. If no voltage is indicated then the power source is faulty. 3. If voltage is present at the power source output terminals it should also be present at the LT7 voltmeter. If not, check leads #21 and #67 for breaks or faulty connections. 4. Remove electrode from drive rolls and press the start switch. Observe light 2K on the logic board. It should be lit. If light 2K does NOT light when the start switch is pressed remove power to unit. Remove lead #682 from CR1. Check the resistance of the coil from the terminal to lead #510. Normal resistance is 10,000 ohms. See wiring diagram. 5. If the relay coil resistance is correct the logic board may be faulty. 6. If light 2K does light make sure the relay (CR1) contacts are making contact. 	<ol style="list-style-type: none"> 1. Check lead #21 for continuity (zero ohms) to "work". 2. Check lead #67 for continuity (zero ohms) to electrode. 3. Check leads #2 and #4 for loose or faulty connections between relay CR1 and the control cable receptacle.

⚠ CAUTION

If for any reason you do not understand the test procedures or are unable to perform the tests/repairs safely, contact the Lincoln Electric Service Department for electrical technical troubleshooting assistance before you proceed. Call 216-383-2531 or 1-800-833-9353

Troubleshooting Guide — See Wiring Diagrams for location of specified components. See Wiring Diagrams for troubleshooting of specific circuits.

Observe Safety Guidelines detailed in the beginning of this manual.

PROBLEMS (SYMPTOMS)	FIELD COURSE OF ACTION	RECOMMENDED SHOP COURSE OF ACTION
FUNCTIONAL PROBLEMS		
<p>No control of power source output from LT7 tractor. Power source does have output.</p>	<ol style="list-style-type: none"> 1. Check control cable leads for proper connection to power source. 2. Make sure the Lincoln power source is in the remote control mode. 	<ol style="list-style-type: none"> 1. Check the continuity of leads #75, #76 and #77 in the control cable. 2. Check the resistance and operation of the voltage control rheostat (R2). Normal resistance is 10,000 ohms. 3. Check the continuity of leads #75, #76 and #77 from the control rheostat (R2) to the control cable receptacle.
<p>The circuit breaker trips while the LT7 is at idle (not feeding wire).</p>	<ol style="list-style-type: none"> 1. Isolate the problem by unplugging the printed circuit boards one at a time and checking to see if circuit breaker trips. 	<ol style="list-style-type: none"> 1. If the problem is not in a printed circuit board then check the wiring harness for "shorts" or grounded leads.

⚠ CAUTION

If for any reason you do not understand the test procedures or are unable to perform the tests/repairs safely, contact the Lincoln Electric Service Department for electrical technical troubleshooting assistance before you proceed. Call 216-383-2531 or 1-800-833-9353

LT-7 TRACTOR



Troubleshooting Guide — See Wiring Diagrams for location of specified components. See Wiring Diagrams for troubleshooting of specific circuits.

Observe Safety Guidelines detailed in the beginning of this manual.

PROBLEMS (SYMPTOMS)	FIELD COURSE OF ACTION	RECOMMENDED SHOP COURSE OF ACTION
FUNCTIONAL PROBLEMS		
<p>The power source output contactor does NOT “drop out”. The power source output terminals are always electrically hot.</p>	<ol style="list-style-type: none"> 1. With the LT7 at idle (not feeding wire) observe light 2K on the logic board. It should not be on. If light 2K IS on the logic board may be faulty. 2. If light 2K is NOT lit (with the LT7 at idle) locate and remove lead #2 on the 1CR relay. If the power source output contactor drops out the 1CR relay may be faulty. 3. If the power source contactor stays “ON” (output terminals electrically hot) with #2 lead removed from 1CR, the problem is in the control cable or the power source. 	
<p>The welding and travel do not stop when the stop switch is pressed.</p>	<ol style="list-style-type: none"> 1. While pressing the stop switch observe light 2C. If light 2C is on the logic board may be faulty. 2. If light 2C is NOT lit (while pressing the stop switch) check the stop switch (S6) and associated leads. 	

⚠ CAUTION

If for any reason you do not understand the test procedures or are unable to perform the tests/repairs safely, contact the Lincoln Electric Service Department for electrical technical troubleshooting assistance before you proceed. Call 216-383-2531 or 1-800-833-9353

Troubleshooting Guide — See Wiring Diagrams for location of specified components. See Wiring Diagrams for troubleshooting of specific circuits.

Observe Safety Guidelines detailed in the beginning of this manual.

PROBLEMS (SYMPTOMS)	FIELD COURSE OF ACTION	RECOMMENDED SHOP COURSE OF ACTION
TRAVEL PROBLEMS		
<p>The travel motor does not run in either the “manual” or “automatic” position.</p>	<ol style="list-style-type: none"> 1. Make sure the circuit breaker is NOT tripped. 2. Set the travel switch in “manual” mode. Check the voltage at the travel board #531 to #632 at the circuit breaker. Normal is 105 to 130VAC. If the correct voltage is NOT present check the circuit breaker, the R5 resistor, the travel switch and the associated wiring. See wiring diagram. 3. If the correct AC voltage IS present at leads #531 to #632 then check the DC voltage at the travel direction switch (S7). (Leads #561 to #559). Normal is 85VDC. with the travel speed set at maximum. If the correct DC voltage is NOT present at leads #561 to #559 the travel board may be faulty. Also check the travel speed control (R6) and the associated wiring. See wiring diagram 	<ol style="list-style-type: none"> 1. Check the DC armature voltage being applied to the travel motor. Leads #595 to #594. Normal is 0 to 85VDC. depending upon the travel speed setting. (Note: In older units the travel motor may be a shunt wound field motor. Normal field voltage is 90 to 110VDC. This may be measured at leads #656 to #657. If field voltage is missing check field fuse F401 on travel board). 2. If the armature voltage is NOT present at leads #595 to #594 check the travel direction switch and associated wiring. See wiring diagram. 3. If the correct armature voltage (and field voltage in older units) IS present perform the Travel Motor Test.

⚠ CAUTION

If for any reason you do not understand the test procedures or are unable to perform the tests/repairs safely, contact the Lincoln Electric Service Department for electrical technical troubleshooting assistance before you proceed. Call 216-383-2531 or 1-800-833-9353



Troubleshooting Guide — See Wiring Diagrams for location of specified components. See Wiring Diagrams for troubleshooting of specific circuits.

Observe Safety Guidelines detailed in the beginning of this manual.

PROBLEMS (SYMPTOMS)	FIELD COURSE OF ACTION	RECOMMENDED SHOP COURSE OF ACTION
TRAVEL PROBLEMS		
<p>The travel motor will not run with travel switch set on "automatic". The motor runs properly with travel switch set to "manual".</p>	<ol style="list-style-type: none"> 1. Check light 2H on logic board. Light 2H should be lit when automatic travel is required. If light 2H does NOT light check the coil resistance of relay 2CR. Normal resistance is 10,000 ohms. 2. If 2CR coil is good and light 2H does NOT light, when automatic travel is required, the logic board may be faulty. 3. If light 2H does light and relay 2CR activates the contacts in 2CR may be faulty. 	<ol style="list-style-type: none"> 1. The travel control switch (S2) or associated wiring may be faulty. See wiring diagram. Check and repair or replace if necessary.
<p>The travel motor runs continuously with travel control switch set on "automatic".</p>	<ol style="list-style-type: none"> 1. Observe light 2H on logic board. Light 2H should only be lit when automatic travel is required. If light 2H is lit continuously the logic board may be faulty. 2. If light 2H lights only when automatic travel is required and is off all other times the contacts in relay 2CR may be stuck closed. Replace relay. 	

⚠ CAUTION

If for any reason you do not understand the test procedures or are unable to perform the tests/repairs safely, contact the Lincoln Electric Service Department for electrical technical troubleshooting assistance before you proceed. Call 216-383-2531 or 1-800-833-9353

LT-7 TRACTOR



Troubleshooting Guide — See Wiring Diagrams for location of specified components. See Wiring Diagrams for troubleshooting of specific circuits.

Observe Safety Guidelines detailed in the beginning of this manual.

PROBLEMS (SYMPTOMS)	FIELD COURSE OF ACTION	RECOMMENDED SHOP COURSE OF ACTION
TRAVEL PROBLEMS		
<p>The travel circuit breaker repeatedly trips.</p>	<ol style="list-style-type: none"> 1. While unit is traveling check the the travel motor armature current. Normal current is 0.5 amps DC. (Note: In older units also check for field voltage of 90 to 110VDC at leads #656 to #657. If field voltage is missing check field fuse F401 on travel board). 2. If the current is too high check for possible excessive external loading of the travel motor such as gummed up gears, excessive cable drag or other obstacles. 3. The travel board may be faulty. 	<ol style="list-style-type: none"> 1. If all tests are good the circuit breaker may be faulty. Test or replace.
<p>The travel motor runs at full speed with no control.</p>	<ol style="list-style-type: none"> 1. Remove power to unit and check the resistance of travel speed control rheostat (R6). Normal resistance is 5000 ohms. Also check R6 for smooth operation. 2. Check associated leads between R6 and the travel board. 3. The travel board may be faulty. 	<ol style="list-style-type: none"> 1. Perform the <i>Travel Motor Test</i>.

 **CAUTION**

If for any reason you do not understand the test procedures or are unable to perform the tests/repairs safely, contact the Lincoln Electric Service Department for electrical technical troubleshooting assistance before you proceed. Call 216-383-2531 or 1-800-833-9353

LT-7 TRACTOR



Troubleshooting Guide — See Wiring Diagrams for location of specified components. See Wiring Diagrams for troubleshooting of specific circuits.

Observe Safety Guidelines detailed in the beginning of this manual.

PROBLEMS (SYMPTOMS)	FIELD COURSE OF ACTION	RECOMMENDED SHOP COURSE OF ACTION
TRAVEL PROBLEMS		
<p>The travel motor runs with limited speed. The control may be erratic.</p>	<ol style="list-style-type: none"> 1. Remove power to unit and check the resistance of travel speed control rheostat (R6). Normal resistance is 5000 ohms. Also check R6 for smooth operation. 2. Check associated leads between R6 and the travel board. 3. The travel board may be faulty. 	<ol style="list-style-type: none"> 1. Perform the <i>Travel Motor Test</i>.

⚠ CAUTION

If for any reason you do not understand the test procedures or are unable to perform the tests/repairs safely, contact the Lincoln Electric Service Department for electrical technical troubleshooting assistance before you proceed. Call 216-383-2531 or 1-800-833-9353

PC BOARD STATUS LIGHTS

Table B.1 is a summary of the on/off states of the LED's on the Control Board, Logic Board and Voltage Board for various conditions of the LT-7. Table B.2 lists the functions that these LED's indicate.

Table B.1 P.C. Board Status Lights

INDICATOR LIGHTS		CONDITIONS FOR LIGHT "ON"						
LIGHT NO.	LOCATION	IDLE MODE	INCH UP SWITCH PRESSED	INCH DOWN SWITCH PRESSED	START SWITCH PRESSED	STOP SWITCH PRESSED	BURNBACK MODE	GROUND LEAD PROTECTOR TRIPPED
1A	CONTR. BD.		ON					
1B	CONTR. BD.			ON	ON			
1C	CONTR. BD.			ON	ON			
1D	CONTR. BD.	ON	ON		ON	ON	ON	ON
1E	CONTR. BD.		ON	ON	ON			
2B	LOGIC BD.				ON			
2C	LOGIC BD.					ON	ON	ON
2D	LOGIC BD.	ON*	ON*	ON*	ON	ON		ON*
2E	LOGIC BD.			ON	ON			
2F	LOGIC BD.	ON	ON	ON			ON	ON
2H	LOGIC BD.				ON			
2J	LOGIC BD.			ON				
2K	LOGIC BD.				ON		ON	
2L	LOGIC BD.				ON			
2M	LOGIC BD.							ON
3A	VOLT BD.			ON	ON		ON	
3B	VOLT BD.			ON	ON		ON	

ON* INDICATES LIGHT IS DIM

Table B.2 P.C. Board Status Light Definitions

LIGHT NUMBER	FUNCTIONS INDICATED BY PC BOARD LEDS
1A	INCH UP SWITCH PRESSED
1B	LOGIC SIGNAL FOR MOTOR TO RUN
1C	DOWN FIELD VOLTAGE APPLIED
1D	UP FIELD VOLTAGE APPLIED
1E	ARMATURE VOLTAGE APPLIED
2B	START SWITCH PRESSED
2C	STOP SWITCH PRESSED
2D	WELD CURRENT PRESENT
2E	SIGNAL TO APPLY DOWN FIELD VOLTAGE
2F	INCH SPEED CIRCUIT OPERATIVE
2H	SIGNAL TO ENERGIZE TRAVEL CIRCUIT
2J	INCH DOWN SWITCH PRESSED
2K	SIGNAL TO OPERATE POWER SOURCE CONTACTOR
2L	WELD VOLTAGE CONTROL OPERATIVE
2M	GROUND LEAD PROTECTOR "TRIPPED"
3A	ELECTRODE VOLTAGE (OUTPUT FROM VV BOARD)
3B	ELECTRODE VOLTAGE (INPUT TO VV BOARD)

LT-7 TRACTOR



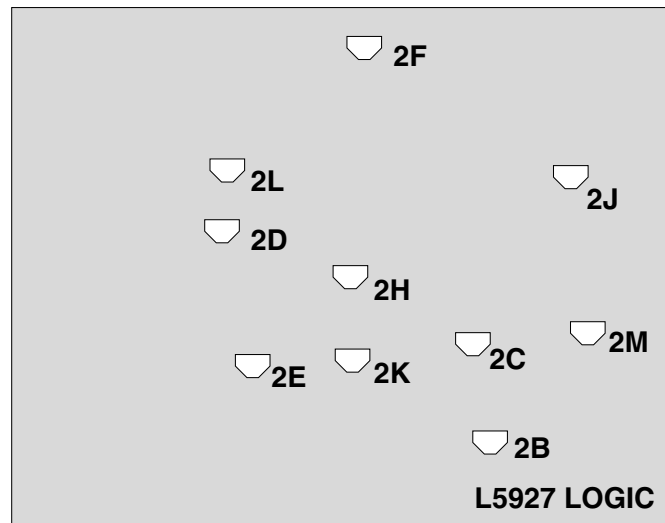

FIGURE B.1 Logic P.C. Board LED Locations

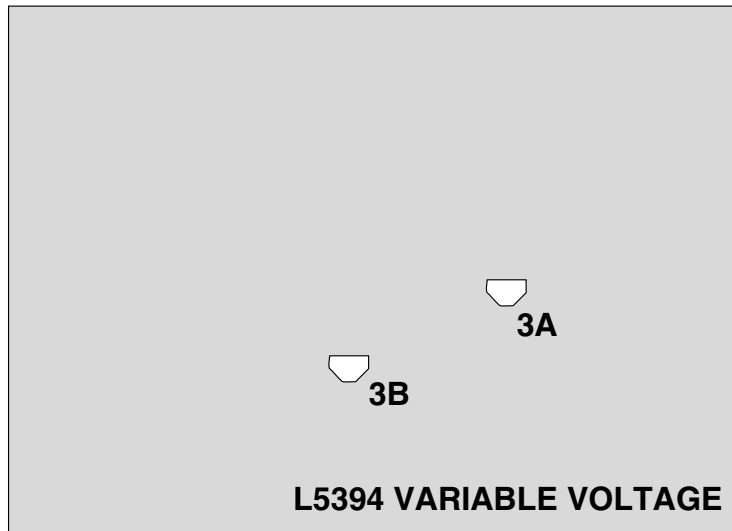

FIGURE B.2 Voltage P.C. Board LED Locations

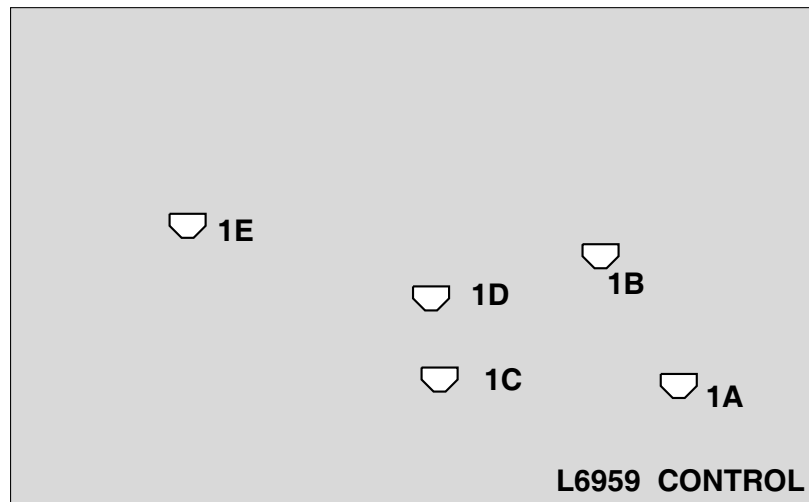

FIGURE B.3 Control P.C. Board LED Locations

LT-7 TRACTOR



WIRE DRIVE MOTOR TEST

WARNING

Service and repair should only be performed by Lincoln Electric factory trained personnel. Unauthorized repairs performed on this equipment may result in danger to the technician or machine operator and will invalidate your factory warranty. For your safety and to avoid electrical shock please observe all safety notes and precautions detailed throughout this manual.

If for any reason you do not understand the test procedures or are unable to perform the test/repairs safely, contact the Lincoln Electric service department for technical troubleshooting assistance before you proceed. Call 216-383-2531 or 1-800-833-9353(WELD).

TEST DESCRIPTION

This test will determine if the wire drive motor is able to function when supplied with the correct voltage.

MATERIALS NEEDED

Variable DC voltage supply 0 to 90VDC.
Isolated DC voltage supply 110VDC.
Volt/ohmmeter

WIRE DRIVE MOTOR TEST (continued)

FIGURE B.4 - Wire Drive Motor Connector Pins

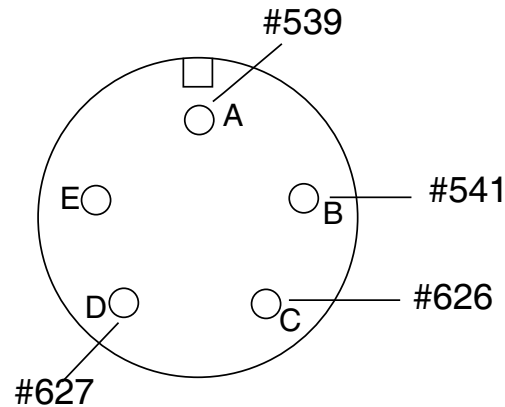
**TEST PROCEDURE**

1. Remove the wire feed motor connector from the LT7 control box.
2. Using the ohmmeter measure the motor resistances per Table B.3. Also see Figure B.4
3. If the motor resistance test is good proceed to the Motor Applied Voltage Test.
3. Apply field voltage first (pins C and D) to the motor. Then slowly apply the armature voltage on pins A and B. (See Table B.3)
4. The motor should run and the speed should vary with changes to the armature voltage.

5. If the motor does NOT run and change speed correctly the motor or gear box may be faulty.

MOTOR APPLIED VOLTAGE TEST

1. Carefully connect the 110VDC supply (SUPPLY TURNED OFF) to pins C and D on the motor connector.
2. Carefully connect the variable 0 to 90VDC supply (SUPPLY TURNED OFF) to pins A and B on the motor connector. (See Table B.3)
6. To stop motor REMOVE ARMATURE VOLTAGE FIRST. (Pins A and B)

TABLE B.3

TEST POINTS	RESISTANCE	DC VOLTAGE
Lead #539 to #541 Armature	4 to 5 ohms	0 to 90VDC
Lead #626 to #627 Field Winding	750 to 850 ohms	90 to 120VDC
All leads to motor shell	500,000 ohms min.	NONE

LT-7 TRACTOR

TRAVEL MOTOR TEST

WARNING

Service and repair should only be performed by Lincoln Electric factory trained personnel. Unauthorized repairs performed on this equipment may result in danger to the technician or machine operator and will invalidate your factory warranty. For your safety and to avoid electrical shock please observe all safety notes and precautions detailed throughout this manual.

If for any reason you do not understand the test procedures or are unable to perform the test/repairs safely, contact the Lincoln Electric service department for technical troubleshooting assistance before you proceed. Call 216-383-2531 or 1-800-833-9353(WELD).

TEST DESCRIPTION

This test will determine if the travel motor is able to function when supplied with the correct voltage.

MATERIALS NEEDED

Variable DC voltage supply 0 to 90VDC.

Isolated DC voltage supply 110VDC. (Only needed for older units with powered field motor).

Volt/Ohmmeter

TRAVEL MOTOR TEST (continued)

TEST PROCEDURE

1. Remove the travel motor connector from the LT7 control box.
2. Using the ohmmeter measure the motor resistances per Table B.4. Also see Figures B.5. and B.6*
3. If the motor resistance test is good proceed to the Motor Applied Voltage Test.
3. *Apply field voltage first (pins C and D) to the motor. See Figure B.6 and Table B.4
4. Slowly apply the armature voltage on pins A and B.(See Table B.4)
- 5.The motor should run and the speed should vary with changes to the armature voltage.

MOTOR APPLIED VOLTAGE TEST

1. *Carefully connect the 110VDC supply (SUPPLY TURNED OFF) to pins C and D on the travel motor connector. See Figure B.6
 2. Carefully connect the variable 0 to 90VDC supply (SUPPLY TURNED OFF) to pins A and B on the travel motor connector.
 - 6.If the travel motor does NOT run and change speed correctly the motor or gear box may be faulty.
 7. *To stop motor REMOVE ARMATURE VOLTAGE FIRST. (Pins A and B)
- *DENOTES OLDER UNITS WITH FIELD WINDING

TABLE B.4

TEST POINTS	RESISTANCE	DC VOLTAGE
Lead #594 to #595 Armature	25 ohms	0 to 90VDC
Lead #559 to #561 Armature*	27 ohms*	0 to 90VDC*
Lead #546 to #547 Field Winding*	500 to 650 ohms*	90 TO 110VDC*
All leads to motor shell	500,000 ohms min.	NONE

*DENOTES OLDER UNITS WITH FIELD WINDING

TRAVEL MOTOR TEST (continued)

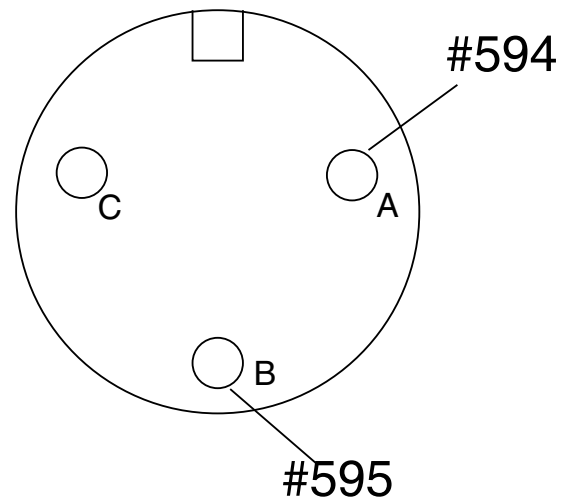

FIGURE B.5 Travel Motor Connector Pins

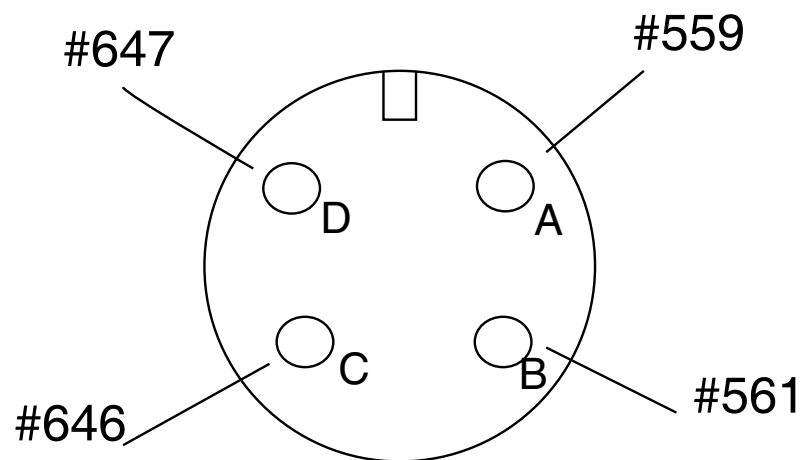

FIGURE B.6 Travel Motor Connector Pins (Older Units with Powered Field.)

LT-7 TRACTOR



WIRE DRIVE MOTOR REMOVAL AND REPLACEMENT

WARNING

Service and repair should only be performed by Lincoln Electric factory trained personnel. Unauthorized repairs performed on this equipment may result in danger to the technician or machine operator and will invalidate your factory warranty. For your safety and to avoid electrical shock please observe all safety notes and precautions detailed throughout this manual.

If for any reason you do not understand the test procedures or are unable to perform the test/repairs safely, contact the Lincoln Electric service department for technical troubleshooting assistance before you proceed. Call 216-383-2531 or 1-800-833-9353(WELD).

MATERIALS NEEDED

1/2" Wrench
Large slot head screwdriver
Small slot head screwdriver
5/32" Allen type wrench

WIRE DRIVE MOTOR REMOVAL PROCEDURE *(continued)***MOTOR REMOVAL PROCEDURE:**

1. Remove the wire drive motor cable from the LT7 control box.
2. Using the 1/2" wrench remove the bolt holding the flux hopper(if used) to the bumper handle assembly.
3. Use the large slot head screwdriver to remove the two slot head screws holding the bumper handle assembly to the gear box housing.
4. Use the 5/32" Allen type wrench to remove the socket head cap screw from the gear box housing and motor end bracket.
5. Locate and remove the four small slot head screws holding the inspection cover plate to the gear box housing. Note placement of rubber gasket and cable strain clamp.
6. Locate and remove the two socket head cap screws mounting the motor to the gear box housing. Note: The inspection cover plate has to be remove (Step #5) to gain access to the two socket head cap screws.
7. Carefully remove the motor(with pinion gear) from the gear box assembly.

MOTOR REPLACEMENT PROCEDURE:

1. Carefully install the replacement motor (with pinion gear) and mount to the gear box housing using the two socket head caps screws.
2. Using the four small slot head screws install the inspection cover plate along with the rubber gasket and cable clamp.
3. Install the bumper handle assembly with the socket head cap screw and the two larger slot head screws.
4. Install the flux hopper (if used) to the bumper handle assembly and secure with the hex head bolt.
5. Attach the wire drive motor cable to the LT7 control box receptacle.

CONNECTION SCHEMATIC - M15342

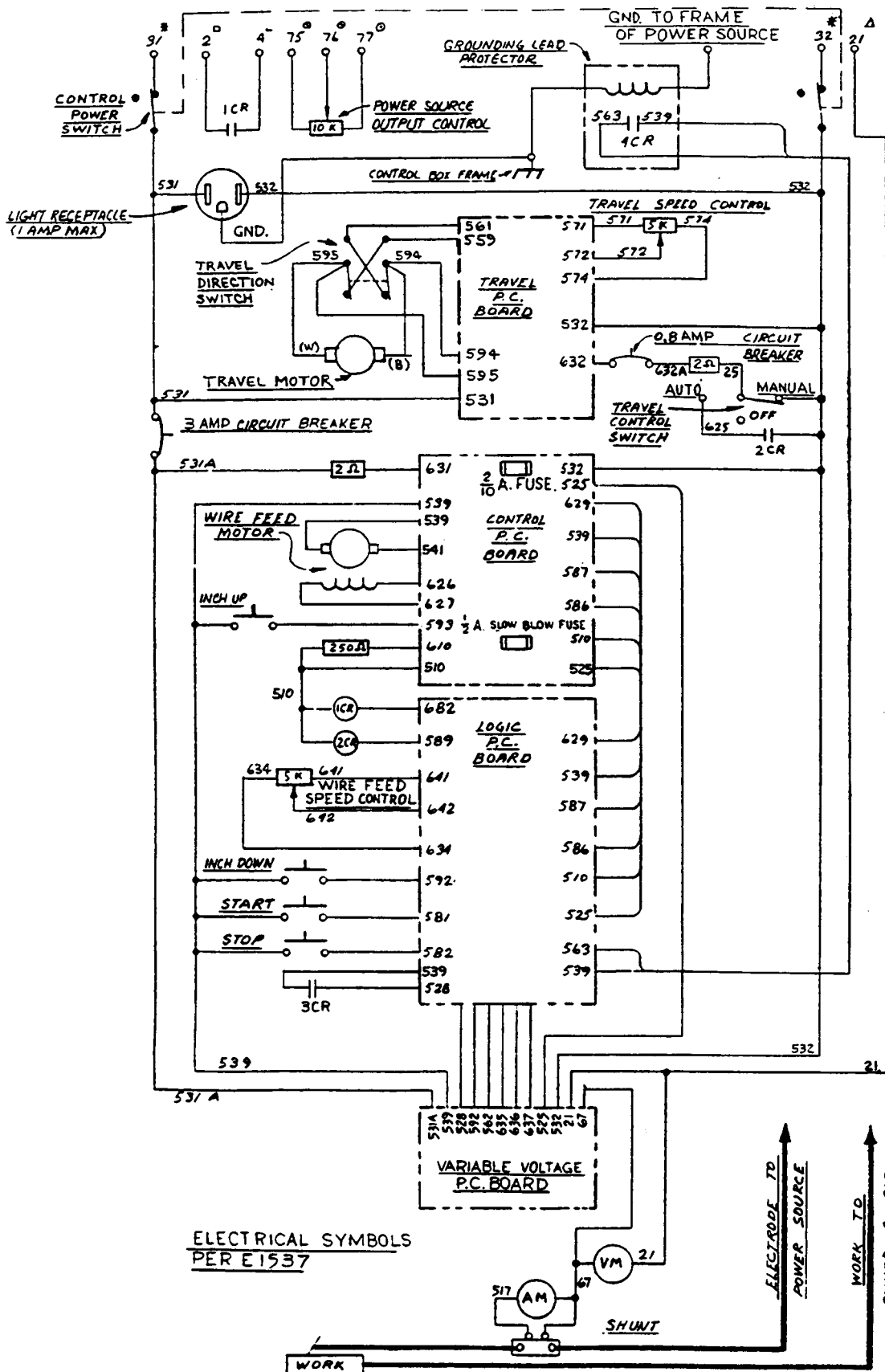

ELECTRICAL SYMBOLS PER E1537

LT-7 TRACTOR



This diagram is provided for reference only. It may not be totally applicable to all machine codes.

CONTROL BOX WIRING DIAGRAM- L7460

This diagram is provided for reference only. It may not be totally applicable to all machine codes.

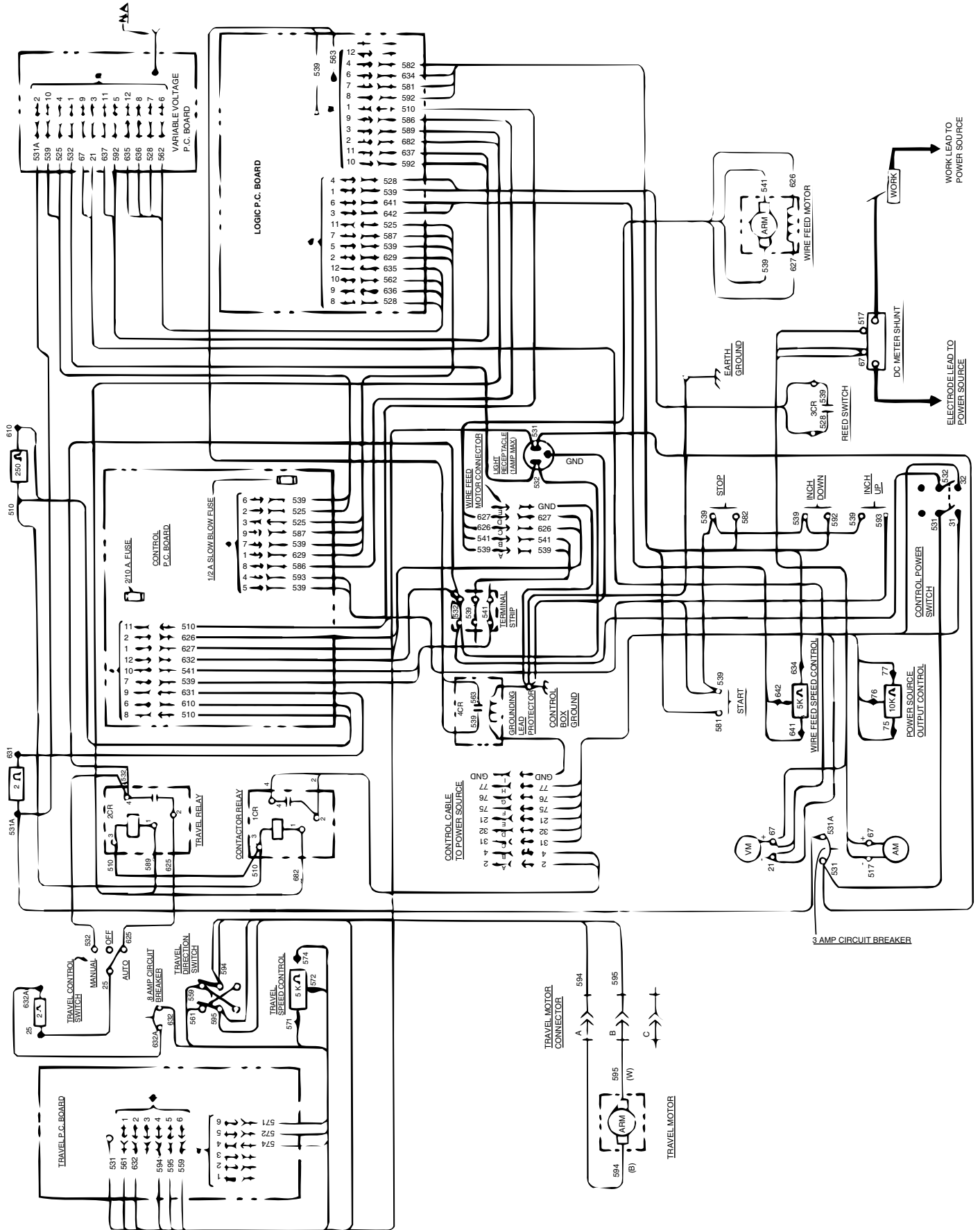

LT-7 TRACTOR



LT-7 TRACTOR



World's Leader in Welding and Cutting Products



Premier Manufacturer of Industrial Motors

• Sales and Service through Subsidiaries and Distributors Worldwide
22801 St. Clair Ave. Cleveland, Ohio 44117-1199 U.S.A. Tel. 216-481-8100